



CERTIFICATE

By Authority Of THE UNITED STATES OF AMERICA Legally Binding Document

By the Authority Vested By Part 5 of the United States Code § 552(a) and Part 1 of the Code of Regulations § 51 the attached document has been duly INCORPORATED BY REFERENCE and shall be considered legally binding upon all citizens and residents of the United States of America. *HEED THIS NOTICE:* Criminal penalties may apply for noncompliance.



Document Name: ANSI Z87.1-2003: Practice for Occupational and Educational Eye and Face Protection

CFR Section(s): 29 CFR 1910.133

Date of Action: 74 FR 40447, Aug. 11, 2009



Official Incorporator:

THE EXECUTIVE DIRECTOR
OFFICE OF THE FEDERAL REGISTER
WASHINGTON, D.C.



AMERICAN NATIONAL STANDARD

*Occupational and Educational
Personal Eye and Face
Protection Devices*



AMERICAN SOCIETY OF
SAFETY ENGINEERS



**American National Standard
Occupational and Educational
Personal Eye and Face
Protection Devices**

Secretariat

American Society of Safety Engineers
1800 East Oakton Street
Des Plaines, Illinois 60018-2187

Approved June 19, 2003

American National Standards Institute, Inc.

Effective August 19, 2003

American National Standard

An American National Standard implies a consensus of those substantially concerned with its scope and provisions. An American National Standard is intended as a guide to aid the manufacturer, the consumer, and the general public. The existence of an American National Standard does not in any respect preclude anyone, whether he/she has approved the standard or not, from manufacturing, marketing, purchasing, or using products, processes, or procedures not conforming to the standard. American National Standards are subject to periodic review and users are cautioned to obtain the latest editions.

The American National Standards Institute does not develop standards and will in no circumstances give an interpretation of any American National Standard. Moreover, no person shall have the right or authority to issue an interpretation of an American National Standard in the name of the American National Standards Institute.

CAUTION NOTICE: This American National Standard may be revised or withdrawn at any time. The procedures of the American National Standards Institute require that action be taken to reaffirm, revise, or withdraw this standard no later than five years from the date of approval. Purchasers of American National Standards may receive current information on all standards by calling or writing the American National Standards Institute.

Published by

**American Society of Safety Engineers
1800 East Oakton Street, Des Plaines, Illinois 60018-2187**

Copyright © 2003 by American Society of Safety Engineers
All rights reserved.

No part of this publication may be reproduced in any form, in an electronic retrieval system or otherwise, without the prior written permission of the publisher.

Printed in the United States of America

For additional copies contact:

American Society of Safety Engineers
1800 East Oakton Street
Des Plaines, Illinois 60018-2187
847-699-2929

Foreword

(This Foreword is not a part of American National Standard Z87.1-2003)

The history of Z87 began with the first edition of the Z2 standard for head and eye protection and was developed from a set of safety standards originally prepared cooperatively by the War and Navy Departments and the National Bureau of Standards.

The second edition of Z2 was developed by a standards committee organized under the American Standards Association and was published in 1922 as the National Bureau of Standards Handbook H2.

In 1938, Z2 was revised to include respiratory protection and was published as the National Bureau of Standards Handbook H24.

In 1946, Z2 was revised to include advances in safety equipment technology such as the use of plastics for eye protection. Three subcommittees were organized. A subcommittee on eye protection was organized under the supervision of the National Bureau of Standards. A subcommittee on respiratory protection was organized under the supervision of the U.S. Bureau of Mines and a subcommittee for head protection was organized under the Department of the Navy. In 1959, Z2 was approved as the American Standard Safety Code for Head, Eye and Respiratory Protection, Z2.1-1959.

On November 24, 1961, the Standards Safety Board approved to divide the Z2 project into three separate standards: Z87 - Industrial Eye Protection; Z88 - Industrial Respiratory Protection; Z89 - Industrial Head Protection. The Z87.1 Standards Committee under the procedures of the USA Standards Institute, formally the American Standards Association, revised the 1959 version, which was approved on September 18, 1968 as the USA Standard Z87.1 - 1968. The USA Standards Institute changed its name in October 1969 to the American National Standards Institute and the Z87.1 Standard became the American National Standard for Occupational and Educational Eye and Face Protection, ANSI Z87.1 - 1968.

In the Z87 Standards Committee, membership was reconstituted and broadened in 1973 to include all organizations with a substantial interest in the design or use of eye and face protection. The Committee revised the 1968 version, which was approved on February 27, 1979 as the American National Standard for Occupational and Educational Eye and Face Protection, ANSI Z87.1 - 1979.

In 1980 the Z87 Standards Committee reconvened to begin their update of the 1979 version. In order to better accommodate advancements in safety equipment technology more emphasis was placed on developing performance oriented standards. A Bureau of Labor Statistics study revealed that most eye injuries to those wearing protectors were caused by insufficient angular protection. Therefore, angular impact testing requirements were included. In 1983, an American Welding Society study was used to update and improve the transmittance requirements for filter lenses. The standard was approved on February 2, 1989 as the American National Standard Practice for Occupational and Educational Eye and Face Protection, ANSI Z87.1-1989. The standard was subsequently reaffirmed by the Z87 Committee per ANSI procedure in 1998 and is still cited by reference by the U.S. Occupational Safety and Health Administration, (OSHA).

This newest edition of the Z87 Standard is considered by the committee members to be significant, as it will strengthen the impact resistance requirements of the standard while still allowing for future technologies and science. This standard once again while voluntary also offers an enhanced user selection chart, which indicates a system of selecting eyewear appropriate to identified hazards. Of importance to users is the knowledge that different types of products, (spectacles, goggles, and face shields) are tested to different levels of impact resistance, thus, it is incumbent upon the user to select a product being tested to the hazard being exposed to.

Suggestions for improvement of this standard are welcome. They should be sent to the American Society of Safety Engineers, 1800 East Oakton Street, Des Plaines, IL 60018 - 2187.

This standard was processed and approved for submittal to ANSI by the Accredited Standards Committee on Safety Standards for Eye Protection, Z87. Committee approval of the standard does not necessarily imply that all committee members voted for its approval. At the time it approved this standard, the Z87 Committee had the following members:

Tod Turriff, Chairman
 Daniel Torgersen, Vice-Chairman
 Timothy R. Fisher, CSP, ARM, CPEA, Secretary
 Patrick Arkins, Assistant Secretary

<u>Organization Represented</u>	<u>Name of Representative</u>
Alliance for Telecommunications Industry Solutions	Steve Barclay
American Academy of Ophthalmology	Paul F. Vinger, M.D.
American Academy of Optometry	Bernard A. Morewitz, O.D., F.A.A.O.
American Ceramic Society	W. Paul Holbrook, Executive Director
American Gas Association	Phillip Bennett
	Kimberly Denbow
American Insurance Association	John Arlington
American Optometric Association	Lowell Glatt, O.D.
	Gregory Good, Ph.D
American Society of Safety Engineers	Jack B. Hirschmann
	Richard Casey, CSP
American Welding Society	Philip M. Johnson
	Jean François Laterre
Edison Electric Institute	Richard Montgomery, CSP
	Charles J. Kelly
Glass Lens Council	John Miller
	Dick Emery
International Safety Equipment Association	John E. Salce
	Janice Comer Bradley, CSP
National Education Association	Richard Verdugo
National Association of Optometrists and Opticians	Lee Handel
National Institute for Occupational Safety and Health (NIOSH)	Franklin D. Rozak
Optical Laboratories Association	Larry L. Jackson, Ph. D.
	James R. Harris, P.E.
	Daniel Torgersen
	Jeffrey Kosh
Opticians Association of America	John M. Young
Prevent Blindness America	Tod Turriff
Society of the Plastics Industry	Hugh Patrick Toner
U.S. Department of Labor/OSHA	Joseph Pipkin
U.S. Department of the Air Force	Anthony Okoren, Lt. Colonel
U.S. Dept. of the Army	Donald McDuffie, Lt. Colonel
U.S. Dept. of the Navy	Dale Barrette, Commander
United Auto Workers Union	Jim Howe, CIH
	Tim McClain
Vision Council of America	Kenneth Wood
	David Devine
ANSI Z80 Committee Ophthalmic Lenses	Robert Dziuban
	Jeffrey Kosh
ANSI Z88 Committee Respiratory Protection	William E. Newcomb, CSP
Z89 Committee Head Protection	James K. Byrnes
	Janice C. Bradley, CSP
ICS Laboratories, Inc.	Dale B. Pfriend, Individual Expert
Individual Expert	Michael W. Schaus

Contents

	TOPIC	PAGE
	FORWARD	2
1	Preface	9
2	Scope, Purpose, Application, Exceptions, Interpretations	9
2.1	Scope	9
2.2	Purpose	9
2.3	Application	9
2.4	Exceptions	10
2.5	Interpretations	10
3	Eye Incident Injury Data/History	10
4	Definitions	10
5	Referenced Publications	13
6	Selection, Use and Maintenance of Protectors	14
6.1	Protectors	14
6.2	Hazard Assessment and Protector Selection	18
7	Spectacles	22
7.1	Introduction	22
7.2	Spectacle Frame Tests	22
7.3	Basic Impact Lens Requirements	22
7.4	Plano Spectacle Lens Requirements	23
7.5	Non-Plano Spectacle Lens Requirements	24
7.6	Flammability	24
7.7	Corrosion Resistance	25
7.8	Cleanability	25
7.9	Replacement Spectacle Lenses	25
7.10	Marking	25
8	Goggles	26
8.1	Introduction	26
8.2	Impact Testing Requirements	26
8.3	High Impact Testing Requirements	27
8.4	Optical Requirements for Plano Goggle Lenses	27
8.5	Optical Requirements for Non-Plano Goggle Performance	28
8.6	Flammability	28
8.7	Corrosion Resistance	28
8.8	Cleanability	28
8.9	Ventilation Requirements	28
8.10	Transmittance of Non-Lens Areas	28
8.11	Replacement Goggle Lenses	28
8.12	Marking	29

Contents

	TOPIC	PAGE
9	Faceshields	29
9.1	Introduction	29
9.2	Impact Testing Requirements	30
9.3	High Impact Testing Requirements	30
9.4	Optical Requirements for Plano Faceshield Windows	31
9.5	Requirements for Wire-Screen Windows	31
9.6	Flammability	31
9.7	Corrosion Resistance	31
9.8	Cleanability	32
9.9	Replacement Faceshield Windows	32
9.10	Marking	32
10	Welding Helmets and Handshields	33
10.1	Introduction	33
10.2	Impact Testing Requirements	33
10.3	High Impact Testing Requirements	34
10.4	Optical Requirements for Plano Welding Helmet Lenses	34
10.5	Optical Requirements for Non-Plano Welding Helmet Lenses	35
10.6	Flammability	35
10.7	Corrosion Resistance	35
10.8	Cleanability	35
10.9	Non-Lens Area Transmittance and Light Tightness	35
10.10	Replacement Welding Helmet Lenses	35
10.11	Marking	36
10.12	Transmittance Requirement, Automatic Darkening Welding Filter Lenses	36
10.13	Cover Lenses	37
11	Respirators	37
11.1	Introduction	37
11.2	Full Facepiece Respirators	37
11.3	Loose Fitting Respirators	37
11.4	Full Facepiece Welding Respirators	37
11.5	Loose Fitting Welding Respirators	37
12	Transmittance Requirements for Clear Lenses, Filter Lenses and Automatic Darkening Filter Lenses	37
12.1	Formulae	38
12.2	Transmittance Requirements	39
12.3	Switching Index Requirements	41
13	Instructions, Use and Maintenance	42
13.1	General Requirements	42
13.2	Instructions	42
13.3	Inspections	42
13.4	Maintenance	42
13.5	Care	42
13.6	Training	42

Contents

TOPIC	PAGE
14 Test Methods	42
14.1 High Mass Impact Test	43
14.2 High Velocity Impact Test	43
14.3 Tests for High Impact Prescription Lenses	44
14.4 Drop-Ball Impact Test	45
14.5 Penetration Test	46
14.6 Flammability Test	47
14.7 Corrosion Resistance Test	47
14.8 Cleanability Test	47
14.9 Prismatic Power Test	48
14.10 Refractive Power, Resolving Power and Astigmatism Tests	48
14.11 Haze Test	49
14.12 Transmittance Test	49
14.13 Switching Index Test	49
14.14 Light Tightness Test	50
15 Warning Label	51
15.1 Purpose	51
15.2 Label or Tag Requirements	51
TABLES	
Table 1 - Transmittance Requirements for Clear and Filter Lenses	40
Table 2 - Transmittance Requirements for Special-Purpose Lenses	41
Table 3 - Switching Index Requirements for Automatic Darkening Welding Filter Lenses	41
FIGURES	
Figure 1 - Spectacles	14
Figure 2 - Temples	14
Figure 3 - Fronts	14
Figure 4 - Bridges	15
Figure 5 - Side Protection	15
Figure 6 - Life-front spectacles	16
Figure 7 - Goggles	16
Figure 8 - Faceshield	17
Figure 9 - Welding Helmets	18
ANNEXES	
Annex A - Spectral Factor Tables (normative)	52
Annex B - Test Apparatus (normative)	56
Annex C - Test Apparatus (informative)	58
Annex D - Calibration of Test Telescope (informative)	60
Annex E - Sources for Test Apparatus (informative)	61
Annex F - Referenced Publications (informative)	62
Annex G - Required Marks and Marking Locations by Product Category (informative)	63
Annex H - Eye Injury Report Form (informative)	64
Annex I - Selection Chart	67

Explanation of Standard

American National Standard Z87.1-2003 uses a column format to provide both specific requirements and supporting information.

Operating rules (safe practices) are not included, unless they are of such a nature as to be vital safety requirements, equal in weight to other requirements, or guides to assist in compliance with the standard.

The information and materials contained in this publication have been developed from sources believed to be reliable. However, the American Society of Safety Engineers (ASSE) as secretariat of the ANSI accredited Z87 Committee or individual committee members accept no legal responsibility for the correctness or completeness of this material or its application to specific factual situations. By publication of this standard, ASSE or the Z87 Committee does not ensure that adherence to these recommendations will protect the safety or health of any persons, or preserve property.

American National Standard Occupational and Educational Personal Eye and Face Protection Devices

1 Preface

This standard for personal eye and face protective devices (hereinafter referred to as protectors) is, as far as possible, designed to be performance oriented. Every effort was made to develop requirements that are consistent with, or more stringent than, ANSI Z87.1-1989(R-1998). This standard recognizes the Bureau of Labor Statistics¹ study that revealed the need for angular protection, in addition to frontal protection, in eye and face protectors worn in the occupational setting.

Protectors do not provide unlimited protection. In the occupational and educational environment, protectors are not substitutes for machine guards and other engineering controls. Protectors alone should not be relied on to provide complete protection against hazards, but should be used in conjunction with machine guards, engineering controls, and sound safety practices. Every effort should be made to eliminate eye and face hazards in occupational and educational settings.

In 1992, the Occupational Safety and Health Administration began regulating occupational exposure to bloodborne pathogens and, as a result, now require employers to provide personal protective equipment (PPE) including eye and face protection for employees exposed to these hazards. At the time of the publication of this standard, no standards existed for eye and face protection intended to provide protection from bloodborne pathogens. Nevertheless many employers have elected to provide their employees with PPE conforming to the requirements of ANSI Z87. These products may or may not provide adequate protection against bloodborne pathogens.

¹ "Accidents Involving Eye Injuries," U.S. Department of Labor, Bureau of Labor Statistics, April 1980, Report 597.

Extreme caution must be exercised in the selection and use of personal protective equipment in applications for which no performance requirements or standardized testing exists.

2 Scope, Purpose, Application, Exceptions, and Interpretations

2.1 Scope

This standard sets forth criteria related to the description, general requirements, testing, marking, selection, care, and use of protectors to minimize or prevent injuries, from such hazards as impact, non-ionizing radiation and chemical type injuries in occupational and educational environments including, but not limited to, machinery operations, material welding and cutting, chemical handling, and assembly operations.

2.2 Purpose

This standard provides minimum requirements for protectors including selection, use, and maintenance of these protectors as devices to minimize or prevent eye and face injuries.

2.3 Application

2.3.1 The requirements of this standard apply to protectors when first placed in service.

2.3.2 Protectors bearing the marking Z87 or represented in any way as being in compliance with this standard, shall meet all requirements of this standard in their entirety. All components of eye and face protective devices shall comply with the requirements of this standard.

2.3.3 Compliance with this standard cannot always be assured when replacement components are used. End users shall exercise extreme care in the selection and installation of replacement components to ensure compliance with this standard.

2.3.4 Components bearing the marking Z87 shall not be used with non-complying components.

2.3.5 The use of a device that is not in compliance with this standard or the use of a protector in applications outside its scope, may result in serious injury or death.

2.4 Exceptions

2.4.1 This standard does not apply to hazardous exposure to bloodborne pathogens, X-rays, high-energy particulate radiation, microwaves, radio-frequency radiation, lasers, masers, and sports, nor does it address comfort and/or appearance features.

2.4.2 This standard, by setting forth its requirements, points out the need to exercise caution in the selection and use of protectors where no performance requirements or standardized testing exist. For example, these protectors may not provide adequate protection against bloodborne pathogens.

2.5 Interpretations

Requests for interpretations of this standard shall be in writing and addressed to the secretariat of this accredited standards committee.

3 Eye Incident Injury Data/History

End users are encouraged fill out an injury report form (Annex H), if there is an incident involving an eye injury. Filling out and submitting the report will enable the committee to build a history, identify potential opportunity areas for standard revisions and increase protection. The report should be sent to American Society of Safety Engineers (ASSE) 1800 East Oakton Street Des Plaines, Illinois 60018.

4 Definitions

For purposes of this standard, the following definitions shall apply:

astigmatism. A condition in a lens of a protector in which there is a difference in refractive power in one meridian from that in another meridian.

Basic Impact Protectors/Lenses. Protectors that are used only in an environment where the known or presumed hazards are of low impact nature.

blue-light transmittance. Transmittance of optical radiation weighted by its ability to cause photochemical damage to the retina.

chin protector. That portion of a device that offers protection to a wearer's chin, lower face and neck.

cleanability. The ability to be made readily free of dirt or grime without being damaged.

cover lens/plate. See "lens/plate, cover"

crown protector. That portion of a device that offers protection to a wearer's forehead.

crown strap. That portion of a headgear that rests on the top of the head.

dark state. The lowest operating luminous transmittance of an automatic darkening filter lens.

diopter (D). A unit of measurement (plus or minus) used to express the power of a lens. It is expressed as the reciprocal of the focusing distance given in meters. The diopter is also used to express the curvature of surfacing tools and the refracting power of curved surfaces.

effective far-ultraviolet transmittance. Transmittance of optical radiation weighted by its ability to damage the cornea with wavelengths from 200 to 315 nanometers.

faceshield. A protective device commonly intended to shield the wearer's face, or portions thereof, in addition to the eyes, from certain hazards, depending on faceshield type. Faceshields shall be used only in conjunction with spectacles and/or goggles.

faceshield, welding. A faceshield intended for limited welding applications. Faceshields shall be used only in conjunction with spectacles and/or goggles.

filter lens. See "lens, filter".

fracture. A lens will be considered to have fractured if it cracks through its entire thickness into two or more separate pieces, or if any lens material visible to the naked eye becomes detached from the inner surface.

frame. A device, which holds the lens or lenses on the wearer.

front. That part of a spectacle or goggle frame that is intended to contain the lens or lenses.

glare. Uncomfortably bright light without hazardous levels of ultraviolet or infrared radiation.

goggle. A protective device intended to fit the face surrounding the eyes in order to shield the eyes from certain hazards, depending on goggle type.

goggle, welding. A goggle intended for limited welding applications.

handshield. A hand-held welding helmet. See "welding helmet."

haze. The percent of incident light that is not transmitted in a straight line through the lens but forward scattered, greater than 2.5° diverging.

headgear. That part of a protective helmet, hood, or faceshield that supports the device on the wearer's head.

High Impact Protectors/Lenses. Protectors that are used in an environment where the known or presumed hazards are of high velocity or high mass or a high impact nature.

hood. A device that completely covers the head, neck, and portions of the shoulders.

infrared radiation (IR). As related to this standard, electromagnetic energy with wavelengths from 780 to 2000 nanometers.

interpupillary distance (PD). The distance in millimeters between the centers of the pupils of the eyes.

lens. The transparent part of a protective device through which the wearer sees, also referred to as a plate or window for some devices.

lens, automatic darkening welding filter. A filter lens, which automatically switches from a light state to a dark state in response to a change of light intensity.

lens, cover. An expendable lens used to protect another lens surface from damage.

lens, filter. A lens that attenuates specific wavelengths of ultraviolet, visible, and infrared radiation.

lens, impact-resistant. A lens capable of withstanding the appropriate impact tests of this standard.

lens, non-removable. A lens and holder that are homogeneous and continuous.

lens, photochromic. A lens, which darkens when exposed to, and fades when removed from, ultraviolet radiation and/or sunlight.

lens, non-plano. Lenses made to an individual prescription (Rx/prescription ophthalmic) or lenses using non-prescription, non-plano lenses for magnifying purposes.

lens, plano (non-Rx). A lens that does not incorporate a corrective prescription; this lens is not necessarily flat. A plano lens is sometimes called afocal.

lens, polarizing. A lens, which transmits light preferentially in particular planes of orientation.

lens, prescription (Rx). A lens manufactured to the wearer's individual corrective prescription.

lens, tinted. A lens with color such as amber, smoke, or cobalt, which does not meet the requirements of Table 1.

lens, welding filter. A lens specified for use for welding or brazing.

lift-front. A type of supplementary lens and holder that covers the viewing area of a protector immediately in front of the wearer's eyes and that can be positioned outside the line of sight.

light. Optical radiation weighted by its ability to cause visual sensations.

light state. The highest operating luminous transmittance of an automatic darkening welding filter lens.

luminous transmittance (T_L). The fraction of light (380-780 nm) passing through a medium.

lux (lx). A unit of measurement of illuminance equal to one lumen per square meter of the illuminated surface.

millisecond (ms). One thousandth of a second; 10^{-3} second.

nanometer (nm). A unit of measurement of wavelength equal to one billionth of a meter; 10^{-9} meter.

NIOSH. National Institute for Occupational Safety and Health, the federal agency responsible for, among other things, certifying

the respiratory protective properties of respirators.

optical density. A measure of the transmittance of an optical device.

optical radiation. As related to this standard, that portion of the electromagnetic spectrum ranging in wavelength from 200 nm to 2000 nm, having the nominal sub-intervals: UV-C (200-280 nm), UV-B (280-315 nm), UV-A (315-380 nm), VISIBLE (380-780 nm), IR-A (780-1400 nm), IR-B (1400-3000 nm), and IR-C (3000 nm-1 mm).

plano. See "lens, plano".

power. See "refractive power", "resolving power", and "prismatic power".

prismatic power, "prism". A measure of the angular deviation expressed in prism diopters (Δ) of a light ray after passing along the viewing path through a lens. (One prism diopter equals deviation of 1 cm per meter of path length.)

protective device, "protector". A complete product meeting the requirements of this standard.

protective helmet. Headwear conforming to ANSI Z89.1-1997, or the latest revision thereof; also known as a "hard hat".

refractive power, "power". A measure of the ability of a lens to focus light rays, expressed in diopters (D).

resolving power, "definition". The measure of the ability of a lens to form separate distinct images of two objects close together.

respirator, full facepiece. A tight fitting respirator that covers the nose, mouth and eyes from approximately the hairline to below the chin.

respirator, loose fitting. A respiratory inlet covering that is designed to form a partial seal with the face, or that completely covers the head and neck, and may cover portions of the shoulder.

respirator, welding. A respirator intended to provide optical radiation protection for welding operations.

retained. In this standard, the use of the word "retained" means that the lens does not separate from the frame by more than 25% of its periphery.

shall. In this standard, the use of the word "shall" indicates a mandatory requirement.

should. In this standard, the use of the word "should" indicates a recommendation.

sideshield. A part of, or attachment to, a spectacle that provides side impact resistance.

spectacles. A protective device intended to shield the wearer's eyes from certain hazards, depending on the spectacle type.

switching index. The response time of an automatic darkening welding filter lens.

temple. That part of a spectacle frame commonly attached to the front and generally extending behind the ear of the wearer.

type tests. One or more tests performed on an item to approve a material, construction, model or design to determine if it is capable of meeting the requirements of a product standard.

ultraviolet radiation (UV). In this standard, electromagnetic energy with wavelengths from 200 to 380 nanometers.

welding goggle. See "goggle, welding".

welding faceshield. See "faceshield, welding".

welding helmet. A protective device intended to provide protection for the eyes and face

against optical radiation and weld spatter, which shall be worn only in conjunction with spectacles or goggles.

window. The lens portion of a faceshield (see "lens").

window, non-removable. A window and holder that are homogeneous and continuous.

5 Referenced Publications

The following standards contain provisions, which, through reference in this text, constitute mandatory provisions of this standard. Other reference materials, which do not contain mandatory provisions, are listed in Annex F.

American Conference of Governmental Industrial Hygienists - *"Relative Spectral Effectiveness by Wavelength"* - 1993-1994.

ANSI Z80.1-1999, *American National Standard for Ophthalmics - Prescription Ophthalmic Lenses - Recommendations.*

ANSI Z80.5-1997, *American National Standard Requirements for Dress Ophthalmic Frames.*

ASTM D635-1998, *Test Method for Rate of Burning and/or Extent and Time of Burning of Self-Supporting Plastics in a Horizontal Position.*

ASTM D1003-00, *Standard Test Method for Haze and Luminous Transmittance of Transparent Plastics.*

ASTM D2240-2002, *Standard Test Method for Rubber Property - Durometer Hardness.*

ASTM D412-1998a, *Standard Test Methods for Vulcanized Rubber and Thermoplastic Rubbers and Thermoplastic Elastomers - Tension.*

NBS Special Publication 374.

6 Selection, Use and Maintenance of Protectors

6.1 Protectors

Protectors are personal protective devices designed to protect the wearer from potential hazards that could adversely affect a person's eyes and/or face. Depending on the potential hazard, the protector may be designed to block flying objects or hazardous liquids, filter optical radiation, or enhance the wearer's vision for performing certain visual tasks. It is also important to realize that different categories are tested at different levels of impact resistance. There are three categories of protector lenses based on transmittance: clear, filter and special purpose (tables 1 and 2). There are many types of protectors available. In the following sections, illustrations of various types of devices used to protect the eyes and face are provided for guidance only; they are not intended to show every type of device available.

6.1.1 Spectacles and Spectacle Components

Spectacles are protective devices designed to shield the wearer's eyes from various impact, or impact and optical radiation hazards. A spectacle commonly consists of the following components: a front, a lens or lenses, a pair of temples, and side protection (figure 1). Spectacle components can be assembled in various combinations to make a complete protector to provide the user with a wide selection of suitable equipment for differing applications.

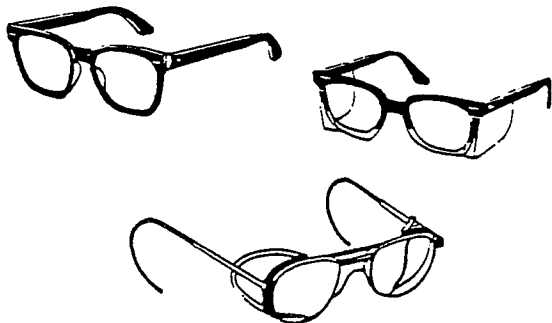

Figure 1 - Spectacles

6.1.1.1 Temples

A temple (figure 2) is that component of a spectacle that extends from the front to just behind the wearer's ear or continues completely around the wearer's head and is used to secure the frame in its proper use position. Temples are usually hinged at the front to permit easy storage when not in use and they are commonly available in the following three types: (1) spatula temples, (2) cable temples, and (3) headband temples. To properly fit the wide variety of wearers, temples are adjustable and/or available in various lengths.



Figure 2 - Temples: spatula, cable and headband

6.1.1.2 Fronts

The front (figure 3) is that component of a spectacle that retains the lens or lenses in the proper orientation for viewing. The front can be a separate part from the lens (removable lens type) or can be molded as an integral part of the lens (non-removable lens type). Frames for prescription lenses usually incorporate the removable type lens front. Cover spectacles are typically the non-removable lens type.



Figure 3 - Fronts: Spectacles with non-removable lenses

6.1.1.3 Lenses

Lenses are that component of a spectacle through which the wearer sees and which provides a protective barrier. Lenses are available in various materials, shapes, thicknesses, shades and tints depending on their particular application. Lenses also can be made to refract or bend light to magnify an object or provide corrective vision to a wearer's individual prescription (Rx). Lenses that do not refract light are considered "plano" and do not provide corrected vision.

6.1.1.4 Bridges/Nose Piece

A bridge or nose piece (figure 4) is that component of a spectacle, which supports the front on a wearer's face and typically rests on the bridge of the wearer's nose. Bridges are commonly available in three types: (1) fixed bridge (non-adjustable), (2) universal/saddle, and (3) adjustable nose pad. Bridge sizes are expressed in millimeters and measured as the distance between lenses (DBL).

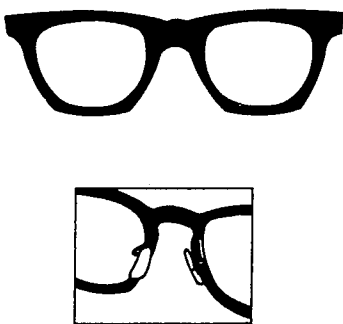

Figure 4 - Bridges: fixed and adjustable nose pad

6.1.1.5 Side Protection

Side protection (Figure 5) is that component of a spectacle that extends from the front to some distance between the front and the wearer's ear and provides limited protection to the wearer's eyes from lateral hazards. Side protection may be an integral part of the frame or lens, a

separate sideshield that is permanently attached to the frame, or a removable part of the frame. The function and coverage of side protection are defined by the high velocity impact test (section 14.2).

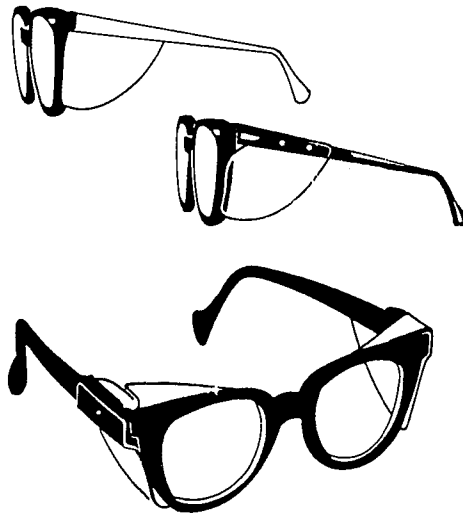

Figure 5 - Side Protection: flatfold sideshields and detachable sideshields

6.1.1.6 Special Purpose Spectacles

Special purpose spectacles are those which use lenses designed for a specific application. Examples of products for such applications include, but are not limited to, sunglasses, notch filters (e.g. - didymium containing), and furnace glasses. Special purpose spectacles use lenses that meet the requirements of table (2).

6.1.1.7 Lift-Front Spectacles

A lift-front spectacle (figure 6) is a spectacle conforming to the requirements of this standard that has an additional permanent or removable front attached, that can be raised or lowered to the wearer's line of sight. The lift-front component is typically used to provide additional protection, as needed, from glare, optical radiation, or both, or is used for special viewing tasks, such as magnification, and is marked accordingly. Lift-front spectacles are

evaluated for impact and optical performance with the lift-front in the up position. The lift-front lens is evaluated for optical performance requirements of 7.4 or 7.5.

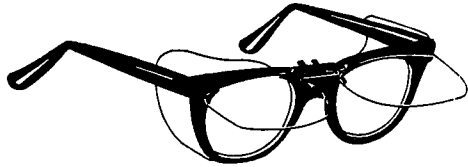

Figure 6 - Lift-front spectacles

6.1.2 Goggles and Goggle Components

Goggles are protective devices designed to fit snugly but not necessarily seal completely to a wearer's face surrounding the wearer's eyes in order to shield the eyes. Goggles provide more protection than spectacles from impact, dust, liquid splash and optical radiation hazards. A goggle commonly consists of the following components: a frame, a lens or lenses, ventilation area and headband.

Goggles (figure 7) are commonly available in two styles: (1) eyecup goggles that cover the eye sockets completely; and (2) cover goggles, which may be worn over spectacles. Goggles are commonly available with rigid or flexible frames and are usually ventilated to minimize fogging. Three different types of ventilation are available: (1) direct ventilation, (2) indirect ventilation, and (3) goggles with no ventilation provision. Direct ventilated goggles permit the direct passage of air from the work environment into the goggle and are not recommended for use in protection against liquid splash hazards. Indirect ventilated goggles permit the passage of air and may prevent the direct passage of liquids and/or optical radiation. Goggles with no provision for ventilation minimize passage of dusts, mist, liquid splash and vapor. Goggles are available in many configurations to provide the user with a wide selection of suitable equipment.

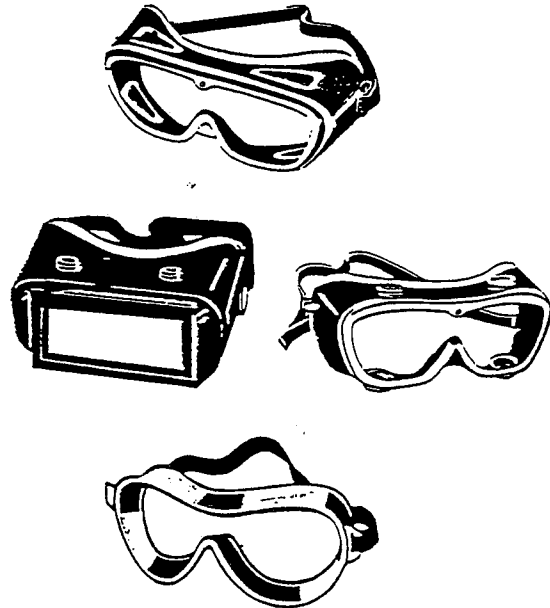
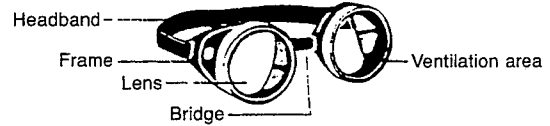

Figure 7 - Goggles: eyecup goggle (showing components), cover goggles with direct ventilation, and indirect ventilation, and non-ventilated goggles

6.1.2.1 Side Protection

Side protection is that component of a goggle that extends from the front to some distance between the front and the wearer's ear and provides limited protection to the wearer's eyes from lateral hazards. Side protection in goggles is commonly an integral part of the frame or lens. The function and coverage of side protection are defined by the high velocity impact test (section 14.2).

6.1.2.2 Lift Front

A lift-front goggle is a goggle conforming to the requirements of this standard that has an additional permanent or removable front attached, that can be raised or lowered to the wearer's line of sight. The lift-front-component is typically used to provide additional protection, as needed, from glare, optical

radiation, or both, or is used for special viewing tasks, such as magnification, and is marked accordingly. Lift-front goggles are evaluated for impact and optical performance with the lift-front in the up position. The lift front lens is evaluated for optical performance requirements of 8.4 or 8.5.

6.1.2.3 Special Purpose Goggles

Special purpose goggles are those which use lenses designed for a specific application. Examples of products for such applications include, but are not limited to, notch filters (e.g. - didymium containing) and furnace goggles. Special purpose goggles use lenses that meet the requirements of table 2.

6.1.3 Faceshields and Faceshield Components

Faceshields are protective devices designed to shield the wearer's face, or portions thereof, in addition to the eyes, from various hazards. Faceshields shall be used only in conjunction with spectacles and/or goggles and provide a higher level of protection than spectacles or goggles alone. Faceshields are used to provide protection from impact, dust, liquid splash and optical radiation hazards. Faceshields (figure 8) may be used with a headgear assembly designed to suspend a transparent window that surrounds and shields the wearer's face. Faceshields may be incorporated with head protection. Faceshields also may provide neck and chin protectors. The assembled devices are available in many combinations of the various component types to provide the user with a wide choice of suitable equipment.

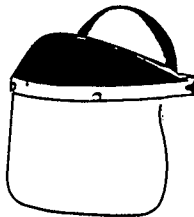

Figure 8 - Faceshield

6.1.3.1 Faceshield Windows

Faceshield windows provide a protective barrier between the work environment and the wearer's eyes and face. Faceshields are available in various materials, shapes, thickness, shades and tints depending on their particular application. Commonly available windows are plastic, plastic with a glass insert, or a wire screen.

6.1.3.2 Special Purpose Faceshields

Special purpose faceshields are those which use windows designed for a specific application. Special purpose faceshields may provide limited protection from impact hazards, optical radiation, or both. Special purpose faceshields meeting certain light transmittance requirements are marked as "light", "medium", or "dark" (section 9.4.5) or meet the requirements of table 2.

6.1.4 Welding Helmets and Handshields

Welding helmets and handshields are protective devices designed to provide protection to a wearer's eyes, face, ears, and front of the neck against optical radiation and weld spatter. Welding helmets and handshields shall be used only in conjunction with spectacles, goggles, or both. There are three types (figure 9) commonly available: (1) helmet with stationary lens, (2) lift-front helmet; and (3) handshield. A welding helmet may be mounted on a protective helmet with special accessories. A welding helmet may be the respiratory inlet covering of a loose fitting facepiece respirator.

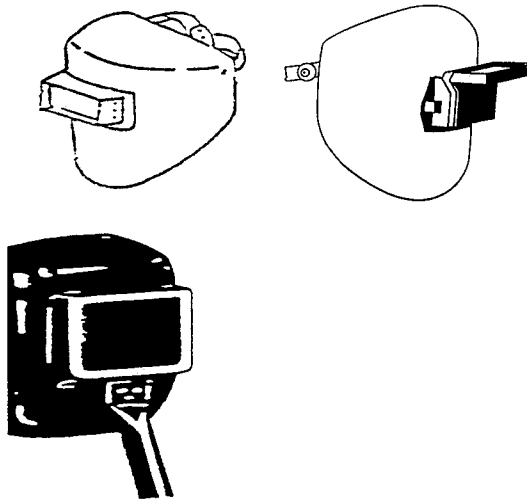

Figure 9 - Welding helmets: helmet with stationary lens, lift-front helmet and handshield

6.1.4.1 Special Purpose Lenses and Windows

Special purpose lenses are designated as such because they do not meet the transmittance requirements of table 1, but do meet the transmittance requirements of table 2. A typical example is a cobalt furnace lens.

Special purpose lenses and windows are further classified and marked in accordance with the requirements of section 10.11. Only devices meeting the applicable sections of this standard shall be used with special purpose lenses. (For additional information, see ANSI Z49.1-1999.)

6.1.5 Respirators

Full facepiece respirators are NIOSH-approved, tight fitting respirators designed to provide a complete seal with the face and to provide protection to the wearer's eyes from impact hazards in addition to eye irritants. Loose fitting respirators are NIOSH-approved respirators designed to provide a partial seal with the face and to provide protection to the wearer's eyes from impact hazards in addition to eye irritants. Welding respirators are NIOSH-approved respirators designed to provide protection to the

wearer's eyes from impact and optical radiation hazards in addition to eye irritants. Depending on the type of welding, the respirator may be designed to provide protection to the face, ears and front of the neck against optical radiation and weld spatter.

6.2 Hazard Assessment and Protector Selection

6.2.1 General Requirements

Protectors shall be required where there is a reasonable probability of an eye or face injury that could be minimized or prevented by the use of such protection. In such cases, employers and educational authorities shall make eye and face protectors conveniently available to employees and students for their use in the work environment, per applicable federal and state regulations. The employees and students shall use such devices. Where there is a reasonable probability of impact from flying objects, a protector with side protection shall be required.

Protectors are not substitutes for engineering controls and sound safety practices. Protectors alone should not be relied upon to provide the sole means of protection against eye and face hazards. Protectors shall be used in conjunction with engineering controls and sound safety practices. Known hazards should be removed or minimized to the extent possible.

Employers and employees should consult their federal, state and local safety and health regulatory authorities to become knowledgeable of the legal requirements applicable to their area. Under the Department of Labor, the Federal Occupational Safety and Health Administration (Fed OSHA) has codified in 29 Code of Federal Regulations (CFR) 1910 *Occupational Safety and Health Standards for General Industry*, and 29 CFR 1926 *Occupational Safety and Health Standards for the Construction Industry* specific legal requirements and guidelines that employers must follow to protect their employees adequately (see specifically 29 CFR 1910.133

and 29 CFR 1926.102). By law, state and local government authorities can implement their own safety and health regulations if they are at least as protective as the federal regulations.

6.2.2 Hazard Assessment

It is necessary to consider certain general guidelines for assessing the eye and face hazard situations that exist in the work environment and to match the protective device to the particular hazard. The person directly responsible for a safety program should apply common sense and fundamental technical principles to accomplish these tasks. This process is subjective by nature because of the infinite variety of situations where face and eye protection may be required. At a minimum, the following recommended hazard assessment procedure should be followed in order to assess the need for eye and face protective equipment.

(1) Survey the Work Area. Conduct a walk-through survey of the area. The purpose of the survey is to identify sources of potential eye and face hazards. Consideration should be given to the six hazard categories addressed by this standard:

- (a) Impact
- (b) Heat
- (c) Chemical (Liquid Splash)
- (d) Dust
- (e) Glare
- (f) Optical Radiation

(2) Identify Sources of Hazards. During the walk-through survey observe:

- (a) Sources of motion; i.e., machinery or processes where any movement of tools, machine elements or particles could exist, or movement of personnel that could result in collision with stationary objects.
- (b) Sources of high temperatures that could result in facial burns, eye injury or ignition of protective equipment, etc.

- (c) Types of chemical exposures.
- (d) Sources of dust.
- (e) Sources of optical radiation, i.e., welding, brazing, cutting, furnaces, heat treating, high intensity light sources and ultraviolet lamps.
- (f) Layout of workplace and location of other personnel.
- (g) Any electrical hazards.

(3) Organize Data. Following the walk-through survey, organize the data and information for use in the assessment of hazards. The objective is to prepare for an analysis of the hazards in the environment to enable proper selection of protective equipment.

(4) Analyze Data. Having gathered and organized data on a workplace, make an estimate of the potential for eye and face injury. Each of the basic hazards should be reviewed and a determination made as to the type and level of each of the hazards found in the area. The possibility of exposure to several hazards simultaneously should be considered.

(5) Selection. Specify the protector(s) suitable for the hazards identified (see Selection Chart, Annex I - Attached at the end of the standard):

(6) Reassessment of Hazards. A periodic reassessment of the work area should be performed on a regular basis to identify changes in the hazard situation that could affect the level of protection required. Reassess the workplace hazard situation by identifying and evaluating new equipment and processes, reviewing accident records, and reassessing the suitability of previously selected eye and face protection.

6.2.3 Protector Selection

After completing a thorough hazard assessment of the environment such as recommended in section 6.2.2, the general procedure for selection

of protective equipment is as follows:

- (1) Become familiar with the Selection Chart (Annex I - Attached at the end of the standard), the types of protective equipment that are available, their capabilities and limitations.
- (2) Compare the hazards associated with the environment, i.e., impact velocities, masses, projectile shape, radiation intensities, etc., with the available protective equipment.
- (3) Make a judgment in selection of the appropriate protective equipment so that the protection is consistent with the reasonably probable hazard.
- (4) Basic impact protectors (lenses) may be used only in an environment where the known or presumed hazards are of low velocity, low mass and low impact nature. High impact protectors shall be used in an environment when the known or presumed hazards are of a high velocity, high mass or high impact nature.
- (5) Provide and fit the user with the protective device and provide instruction on its care, use and limitations as recommended in sections 6.2.4 and 6.2.6.

(Note: Be aware that spectacles, goggles, and face shields are tested with different impact criteria so the protector selection should be consistent to the testing.)

The Selection Chart (Annex I - Attached at the end of the standard) is intended to aid in identifying and selecting the types of eye and face protectors that are available. The capabilities and limitations for the hazard "source" operations are listed in this guide. This guide is not intended to be the sole reference in selecting the proper eye and face protector.

6.2.4 Product Use and Limitations

Protectors are a personal item. They should be issued for exclusive use by a particular individual. However, in circumstances where protectors are reissued, the protectors shall be maintained in a sanitary and reliable condition as described in section 6.2.6.

Employers and educational authorities should train their employees and students in the proper use, care, application, inspection, maintenance, storage, and limitations of protective devices and provide them with all warnings, cautions, instructions and limitations

included with the protector by the manufacturer. The wearer should follow all instructions provided by the manufacturer.

Caution shall be exercised to ensure that the level of protection provided by any protector is adequate for its intended purpose.

See the Selection Chart (Annex I - Attached at the end of the standard), for information on specific applications.

For more information regarding training please review the American National Standard, Z490.1-2001, "Criteria for Accepted Practices in Safety, Health, and Environmental Training".

6.2.4.1 Special Purpose Protectors and Lenses

Special purpose protectors and lenses are those which meet the requirements of table 2, but do not meet the requirements of table 1. They are designed for specific applications. They might not provide adequate ultraviolet protection, infrared protection, or ultraviolet and infrared protection when used for applications for which they are not designed. Therefore, special purpose protectors and lenses shall be used only after a complete hazard assessment and at the discretion of the individual responsible for the selection of protectors.

6.2.4.2 Prescription (Rx) Eyewear

Wearers of prescription (Rx) eyewear shall wear eye protection that incorporates the prescription in its design or that can be worn over prescription lenses without disrupting either the prescription eyewear or the protective eyewear.

Contact lens wearers should recognize that dusty and/or chemical environments may represent an additional hazard. Contact lenses are not protective devices. Wearers of contact lenses shall wear appropriate protectors in hazardous environments.

6.2.4.3 Filter Lenses and Windows

A filter lens meets the ultraviolet, luminous and infrared transmittance requirements of table 1 and is marked with a shade number that indicates its transmittance levels in accordance with table 1. Filter lenses of an appropriate shade are suitable for protection from direct exposure to optical radiation from sources of very high radiance, such as welding arcs. Filter lenses are also suitable for protection from sources of low radiance, provided that they are not so dark as to interfere with normal visual performance of the task.

6.2.4.4 Tinted Lenses and Windows

Lenses having low luminous transmittance should not be worn indoors, except when needed for protection from optical radiation. Care should be exercised in conjunction with wearing such lenses for driving vehicles with tinted windshields or for night driving. Some polarized lenses may present viewing problems when reading liquid crystal displays. Some tinted lenses may absorb certain wavelengths of visual displays or signs, rendering them unreadable.

6.2.4.5 Photochromic Lenses

Photochromic lenses darken when exposed to, and fade when removed from, ultraviolet radiation or sunlight. They are frequently used to provide comfortable vision for a wide range

of ambient illumination. They should be used with care where the wearer passes from outdoors to indoors in the course of the job. Photochromic lenses that do not meet the transmittance requirements of table 1 and the switching index requirements of table 3 are not suitable for protection from direct exposure to high radiance sources (e.g., welding arcs and unshielded high intensity lamps). Photochromic lenses that do not meet the switching index requirements in table 3 are not automatic darkening welding filters. Photochromic lenses shall be used only after a complete hazard assessment and at the discretion of the person responsible for the selection of protectors, (See the Selection Chart, Annex I - Attached at the end of the standard.)

6.2.4.6 Protection from Low Radiance Sources of Ultraviolet and Visible Radiation

Some lenses that comply with the transmittance requirements of table 2, but not with all of the requirements of table 1, can provide sufficient ultraviolet attenuation to be used for protection from direct exposure to ultraviolet sources of low radiance and from indirect exposure (i.e., scattered radiation) to properly shielded ultraviolet sources of high radiance. Lenses that have some attenuation of visible light may also be suitable for protection from scattered light from properly shielded high radiance sources of visible light, (See Selection Chart, Annex I - Attached at the end of the standard.)

6.2.5 Fitting the Device

Careful consideration should be given to comfort and fit. Protectors that fit poorly will not afford the protection for which they were designed. Protectors should be fitted by qualified personnel. Continued wearing of protectors is more likely when they fit the wearer comfortably. Protectors are generally available in a variety of styles and sizes and care should be taken to ensure that the right size is selected for a particular person. For devices with adjustable fitting features, adjustments should be made on a regular and individual basis for a

comfortable fit, which will maintain the protective device in its proper wearing position.

Some protectors may not be compatible with other personal protective equipment when worn together, such as goggles with faceshields, goggles with respirators and spectacles with goggles. The end user should carefully match protectors with other personal protective equipment to provide the protection intended. Because of individual facial characteristics, care must be exercised in fitting goggles to ensure that a snug fit around the face is achieved in order to provide adequate protection.

6.2.6 Inspection, Care and Maintenance

Wearers shall perform a visual inspection of their protectors prior to each use. Protective devices that are distorted, broken or excessively scratched or pitted are not suitable for use and shall be discarded.

Reasonable care shall be taken during the use and storage of protectors so that they are not subject to unnecessary abuse.

Protectors shall be maintained in a usable condition in accordance with manufacturer's instructions. When one protector is being used by more than one person, it is recommended that it be cleaned and disinfected prior to being used by a different individual.

7 Spectacles

7.1 Introduction

Spectacles are protective devices designed to shield the wearer's eyes from certain hazards. Spectacles may be available in basic impact and high impact classes. Spectacles may in many cases be used alone. When faceshields or welding helmets are required, spectacles, goggles, or both shall be worn in conjunction with them (see Selection Chart, Annex I - Attached at the end of the standard).

7.2 Spectacle Frame Test

Spectacle frame tests are designed to test the ability of the frame to retain a lens upon impact and to evaluate the strength of the temples and/or sideshields. For the purpose of these tests, frames shall be equipped with test lenses. The test lenses for frames designed for non-plano spectacles shall be 2.0 mm, + 0.2mm, -0.0 mm (0.079 in, +0.008 in, - 0.0 in) thick. A test lens shall be capable of withstanding the following test criteria without failure. All spectacle frames shall meet the high mass and high velocity impact requirements of 7.2.1 and 7.2.2.

7.2.1 High Mass Impact

Spectacle frames shall be capable of resisting an impact from a pointed projectile weighing 500 g (17.6 oz) dropped from a height of 127 cm (50.0 in). The spectacles shall be tested in accordance with section 14.1. No piece shall be detached from the inner surface of any frame component, and the test lens shall be retained in the frame.

7.2.2 High Velocity Impact

Spectacle frames shall be capable of resisting impact from a 6.35 mm (0.25 in) diameter steel ball traveling at a velocity of 45.7 m/s (150 ft/s). The spectacles shall be tested in accordance with section 14.2. No contact with the eye of the headform is permitted as a result of impact. No piece shall be detached from the inner surface of any frame component, and the test lens shall be retained in the frame.

7.3 Basic Impact Lens Requirements

Basic impact spectacle lenses shall comply with all subparagraphs of this section.

7.3.1 Drop Ball Impact

Basic impact spectacle lenses shall be capable of resisting impact from a 25.4 mm (1 in) diameter steel ball dropped from a height of 127

cm (50.0 in). The lens shall be tested in accordance with section 14.4. The lens shall not fracture as a result of this test.

Glass lenses shall be individually tested. Statistical sampling is an acceptable means of demonstrating compliance for plastic lenses. An example of an acceptable plan is in ANSI/ASQC Z1.4-1993, *Sampling Procedures and Tables for Inspection by Attributes*.

7.3.2 Minimum Thickness

Basic impact spectacle lenses shall be not less than 3.0 mm (0.118 in) thick, except those lenses having a plus power of 3.00 D or greater in the most plus meridian in the distance portion of the lens which shall have a minimum thickness no less than 2.5mm (0.098 in).

7.3.3 Plastic Lens Penetration Test

Basic impact plastic spectacle lenses shall be capable of resisting penetration from a weighted projectile weighing 44.2 gm (1.56 oz) dropped from a height of 127 cm (50.0 in) when tested in accordance with section 14.5. The lens shall not fracture or be pierced through as a result of this test.

7.4 Plano Spectacle Lens Requirements

7.4.1 Basic Impact Testing Requirements

Plano lens products designed to meet basic impact requirements shall comply with section 7.3.

7.4.2 High Impact Testing Requirements

7.4.2.1 Spectacle Product Tests

The spectacle product test is designed to test the capability of the complete product, both removable and non-removable lens products, to meet the requirements of this standard. For purposes of product testing, spectacles shall be tested as a complete device.

7.4.2.1.1 High Mass Impact

High impact spectacles shall be capable of resisting an impact from a pointed projectile weighing 500 g (17.6 oz) dropped from a height of 127 cm (50.0 in). The spectacles shall be tested in accordance with section 14.1. No piece shall be detached from the inner surface of any spectacle component and the lens shall be retained in the frame. In addition, the lens shall not fracture.

7.4.2.1.2 High Velocity Impact

High impact spectacles shall be capable of resisting impact from a 6.35 mm (0.25 in) diameter steel ball traveling at a velocity of 45.7 m/s (150 ft/s). The spectacles shall be tested in accordance with section 14.2. No contact with the eye of the headform is permitted as a result of impact. No piece shall be detached from the inner surface of any spectacle component and the lens shall be

retained in the frame. In addition, the lens shall not fracture.

7.4.2.1.3 Penetration Test (For Plastic lenses only)

High impact plano spectacle lenses shall be capable of resisting penetration from a weighted projectile weighing 44.2 gm (1.56 oz) dropped from a height of 127 cm (50.0 in) when tested in accordance with section 14.5. The lens shall not fracture or be pierced through as a result of this test. No piece shall be detached from the inner surface of any spectacle component and the lens shall be retained in the frame.

7.4.2.2 Thickness

When used in a frame marked Z87-2, the lenses shall be not less than 2.0 mm (0.079 in) thick.

7.4.3 Optical Requirements

When tested alone, lens/plate shall meet all optical requirements for plano spectacles.

7.4.3.1 Optical Qualities

The lenses shall be free of striae, bubbles, waves and other visible defects and flaws which would impair their optical quality per the specifications and test methods in ANSI Z80.1- 1999.

7.4.3.2 Prismatic Power

Complete devices shall be tested in accordance with section 14.9. The prismatic power shall not exceed 0.50 Δ in any direction. Vertical prism imbalance shall not exceed 0.25 Δ , and horizontal prism imbalance shall not exceed 0.25 Δ "Base In" or 0.50 Δ "Base Out".

7.4.3.3 Refractive Power

Complete devices shall be tested in accordance with section 14.10. The refractive power, in any meridian, shall not exceed +/- 0.06 D. The maximum astigmatism (the absolute difference in power measured in the two extreme meridians) shall not exceed 0.06 D.

7.4.3.4 Resolving Power

Lenses shall be tested for resolving power in accordance with section 14.10. All lines in both orientations of NBS Pattern 20 shall be clearly resolved.

7.4.3.5 Haze

Clear plano lenses shall exhibit not more than 3% haze when tested in accordance with section 14.11.

7.4.3.6 Transmittance

Plano lenses shall comply with the requirements specified in table 1 for clear or filter lenses, or table 2 for special purpose lenses. Measurements shall be taken in accordance with section 14.12.

7.5 Non-Plano Spectacle Lens Requirements**7.5.1 Basic Impact**

Basic impact non-plano lenses shall satisfy all the requirements of sections 7.3.1, and 7.3.2.

7.5.2 High Impact

High impact non-plano spectacle lenses shall comply with all subparagraphs of this section.

7.5.2.1 High Velocity Impact

High impact non-plano lenses shall be capable of resisting an impact from a 6.35 mm (0.25 in) diameter steel ball traveling at a velocity of 45.7 m/s (150 ft/s). The lenses shall be tested in accordance with section 14.3. No piece shall be detached from the inner surface of the lens. In addition, the lens shall not fracture.

7.5.2.2 Minimum Thickness

High impact non-plano lenses shall be not less than 2.0 mm thick. This requirement is in recognition of the thickness needed to maximize lens retention in the frame in a high velocity impact.

7.5.3 Optical Qualities

Non-plano spectacle lenses shall comply with the optical quality requirements of ANSI Z80.1-1999.

7.5.4 Transmittance

Non-plano lenses shall comply with the requirements specified in table 1 for clear lenses or table 2 for special purpose lenses. Measurements shall be taken in accordance with section 14.12.

7.6 Flammability

The front, temple, lens and removable sideshields shall be tested in accordance with section 14.6. The material shall not burn at a rate greater than 76 mm (3 in) per minute.

7.7 Corrosion Resistance

Spectacles shall be tested in accordance with section 14.7. Metal components used in spectacles as utilized on the device shall be corrosion resistant to the degree that the function of the spectacles shall not be impaired by the corrosion. Lenses and electrical components are excluded from these requirements.

7.8 Cleanability

Spectacles shall be capable of being cleaned in accordance with section 14.8. The function and markings of the spectacles shall not be impaired by the cleaning process.

7.9 Replacement Spectacle Lenses

Since this standard allows for a great variety of spectacle lens shapes, sizes, and retention systems, compliance with this standard cannot always be assured when replacement lenses are used. Users shall exercise extreme care in the selection and installation of replacement lenses. To ensure compliance with this standard all replacement lenses shall be capable of meeting the same performance requirements as the replaced lenses. Only those replacement lenses designated by the lens manufacturer to be compatible with a particular spectacle model shall be used as a component of that spectacle. This information shall be supplied with the replacement lenses.

7.10 Marking

All markings shall be permanent, legible, and placed so that interference with the vision of the wearer is minimal. For a summary table of required markings see Annex G.

7.10.1 Frame Marking for Products with Removable Lenses

Spectacle frames including the front, both temples, and removable sideshields shall be

marked with the manufacturers mark or symbol and "Z87". If the frame is intended for non-plano lenses, the front and both temples shall be marked with the manufacturers mark or symbol and "Z87-2".

In addition, the components of frames that are intended for non-plano use shall be marked for size in accordance with the system described in ANSI Z80.5-1997. Fronts shall be marked with the A-dimension (eye size) and DBL (distance between lenses). Temples shall be marked with their overall length.

7.10.2 Removable Lens Marking

Removable lenses shall be marked as follows:

Mark	Indication
Mark or Logo	Identification of manufacturer. Complies with Basic Impact Testing Requirements of sections 7.4.1 or 7.5.1.
Mark or Logo	Identification of manufacturer. Complies with High Impact Testing Requirements of sections 7.4.2 or 7.5.2.
+	Complies with High Impact Testing Requirements of sections 7.4.2 or 7.5.2.
Shade Number	Filter lens which complies with table 1 .
S	Special purpose lens, complies with table 2, but not with table 1.
V	Photochromic lens.

7.10.2.1 Examples of Lens Marking

Assume that manufacturer "K" makes a Special Purpose lens which meets basic impact requirements. That lens would be marked as follows:

KS

Assume that manufacturer "W" makes a lens which meets the table 1 requirements of a shade 2.5 filter and meets high impact testing requirements. That lens would be marked as follows:

W + 2.5

Assume that manufacturer "Y" makes a clear lens, which meets table 1 and high impact testing requirements. That lens would be marked as follows:

Y+

7.10.3 Marking for products with Non-removable Lenses

Spectacles with non-removable lenses shall require only one marking. This marking may be placed on the front or one of the temples and shall consist of the manufacturer's identifying mark or symbol, "Z87" indicating compliance with this standard, a shade number if applicable and a "+" indicating that it meets the high impact testing requirements.

8 Goggles

8.1 Introduction

Goggles are protective devices intended to fit the face immediately surrounding the eyes in order to shield the eyes from a variety of hazards. While goggles may be used alone, they may also be used in conjunction with other protectors.

8.2 Impact Testing Requirements

8.2.1 Goggle Frame Tests

For the purpose of these tests, goggle frames shall be equipped with test lenses. A test lens shall be capable of withstanding the specified test criteria without failure.

8.2.1.1 High Mass Impact

Goggle frames shall be capable of resisting an impact from a pointed projectile weighing 500 g (17.6 oz) dropped from a height of 127 cm (50.0 in). The goggle shall be tested in accordance with section 14.1. No piece shall be detached from the inner surface of any goggle component and the lens shall be retained in the frame. If the goggle uses only one lens, then it shall not separate from the frame along more than 25% of its periphery.

8.2.1.2 High Velocity Impact

Goggle frames shall be capable of resisting impact from a 6.35 mm (0.25 in) diameter steel ball traveling at a velocity of 76.2 m/s (250 ft/s). The goggles shall be tested in accordance with section 14.2. No contact with the eye of the headform is permitted as a result of impact. No piece shall be detached from the inner surface of any goggle component and the lens shall be retained in the frame. If the goggle uses only one lens, then it shall not separate from the frame along more than 25% of its periphery.

8.2.2 Basic Impact Lens Tests

For the purposes of these tests, goggle lenses shall be tested individually.

8.2.2.1 Drop Ball Impact

Basic impact goggle lenses shall be capable of resisting the impacts specified below. The lens shall be tested in accordance with section 14.4. The lens shall not fracture as a result of this test.

Round, removable lenses that are clear or that have shade numbers 1-3 shall be capable of resisting impact from a 25.4 mm (1 in) diameter steel ball, weighing 68 g (2.4 oz), dropped from a height of 127 cm (50.0 in). For shades higher than shade 3, round removable lenses shall be capable of resisting impact from a 22 mm (7/8 in) diameter steel ball, weighing 44.2 g (1.56 oz), dropped from a height of 1.0 m (39 in).

8.2.2.2 Minimum Thickness

Basic impact goggle lenses shall be not less than 3.0 mm (.118 in) thick at their thinnest point, except plastic, which shall be not less than 1.27 mm (.050 in) thick at its thinnest point.

8.2.2.3 Plastic Lens Penetration Test

Basic impact plastic goggle lenses shall be capable of resisting penetration from a weighted projectile weighing 44.2 g (1.56 oz) dropped from a height of 127 cm (50.0 in) when tested in accordance with section 14.5. The lens shall not fracture or be pierced through as a result of this test.

8.3 High Impact Testing Requirements**8.3.1 Goggle Product Tests**

For purposes of product testing, goggles shall be tested as a complete device. Goggles with lift fronts shall be tested for impact resistance and optical requirements with the lift front in the "up" position.

8.3.1.1 High Mass Impact

High impact goggles shall be capable of resisting an impact from a pointed projectile weighing 500 g (17.6 oz) dropped from a height of 127 cm (50.0 in). The goggles shall be tested in accordance with section 14.1. No piece shall be detached from the inner surface of any goggle component and the lens shall be retained in the frame. If the goggle uses only one lens, then it shall not separate from the frame along more than 25% of its periphery. In addition, the lens shall not fracture.

8.3.1.2 High Velocity Impact

High impact goggles shall be capable of resisting impact from a 6.35 mm (0.25 in) diameter steel ball traveling at a velocity of 76.2 m/s (250 ft/s). The goggles shall be tested in accordance with section 14.2. No contact with the eye of the headform is permitted as a result of impact. No piece shall be detached from the

inner surface of any goggle component and the lens shall be retained in the frame. If the goggle uses only one lens, then it shall not separate from the frame along more than 25% of its periphery. In addition, the lens closest to the eye shall not fracture.

8.3.1.3 Penetration Test

High impact goggle lenses shall be capable of resisting penetration from a weighted projectile weighing 44.2 gm (1.56 oz) dropped from a height of 127 cm (50.0 in) when tested in accordance with section 14.5. The lens closest to the eye shall not fracture or be pierced through as a result of this test. No piece shall be detached from the inner surface of a goggle component and the lens shall be retained in the frame.

8.4 Optical Requirements for Plano Goggle Lenses

When tested alone, the lens/plate shall meet all optical requirements.

8.4.1 Optical Qualities

The lenses shall be free of striae, bubbles, waves and other visible defects and flaws which would impair their optical quality.

8.4.2 Prismatic Power

Complete devices shall be tested in accordance with section 14.9. The prismatic power shall not exceed 0.25 Δ in any direction. Vertical prism imbalance shall not exceed 0.125 Δ , and horizontal prism imbalance shall not exceed 0.125 Δ "Base In" or 0.50 Δ "Base Out".

8.4.3 Refractive Power

Complete devices shall be tested in accordance with section 14.10. The refractive power, in any meridian, shall not exceed +/- 0.06 D. The maximum astigmatism, the absolute difference in power measured in the two extreme meridians, shall not exceed 0.06 D.

8.4.4 Resolving Power

Lenses shall be tested for resolving power in accordance with section 14.10. All lines in both orientations of NBS Pattern 20 shall be clearly resolved.

8.4.5 Haze

Clear plano lenses shall exhibit not more than 3% haze when tested in accordance with section 14.11.

8.4.6 Transmittance

Plano lenses shall comply with the requirements specified in table 1 for clear lenses or table 2 for special purpose lenses. Measurements shall be taken in accordance with section 14.12.

8.5 Optical Requirements for Non-Plano Goggle Performance

8.5.1 Optical Requirements

Non-plano lenses shall comply with the optical requirements of ANSI Z80.1-1999.

8.5.2 Transmittance

Non-plano lenses shall comply with the requirement specified in table 1 for clear or filter lenses, or table 2 for special purpose lenses. Measurements shall be taken in accordance with section 14.12. Note: Most non-plano lenses do not comply with the requirements of table 1.

8.6 Flammability

The frame, lens and lens housing or carrier shall be tested in accordance with section 14.6. The material shall not burn at a rate greater than 76 mm (3 in) per minute.

8.7 Corrosion Resistance

Goggles shall be tested in accordance with section 14.7. Metal components used in goggles shall be corrosion resistant to the degree that the function

of the goggles shall not be impaired by the corrosion. Lenses and electrical components are excluded from these requirements.

8.8 Cleanability

Goggles shall be capable of being cleaned in accordance with section 14.8. The function and markings of the goggles shall not be impaired by the cleaning process.

8.9 Ventilation Requirements

When goggles are provided with openings to allow circulation of air, venting shall be consistent with the intended application of the goggles.

8.9.1 Direct Ventilation

The vented portion of a goggle shall be such that openings shall exclude spherical objects 1.5 mm (0.059 in) in diameter or larger.

8.9.2 Indirect Ventilation

The vented portion of a goggle shall be such that no direct, straight line passage from the exterior to the interior of the goggle exists.

8.10 Transmittance of Non-Lens Areas

When tested in accordance with section 14.12, non-lens areas of welding goggles with removable lenses shall transmit no more optical radiation than that permitted by table 1 for shade number 8. Non-lens areas of welding goggles with non-removable lenses shall transmit no more optical radiation than that of their lens.

8.11 Replacement Goggle Lenses

Since this standard allows for a great variety of goggle lens shapes, sizes, and retention systems, compliance with this standard cannot always be assured when replacement lenses are used. Users shall exercise extreme care in the selection and installation of replacement lenses. To ensure compliance with this standard all replacement lenses shall be capable of

meeting the same performance requirements as the replaced lenses. Except for 50 mm (1.97 in) round and 51 x 108 mm (2.00 x 4.25 in) rectangular lenses, only those replacement lenses designated by the manufacturer to be compatible with a particular goggle model shall be used as a component of that goggle. This information shall be supplied with the replacement lens(es).

50 mm (1.97 in) round and 51 x 108 mm (2.00 x 4.25 in) rectangular lenses shall have dimensional tolerances of: Round +/- 0.2 mm (0.008 in) and Rectangular +/- 0.8 mm (0.031 in).

8.12 Marking

All markings shall be permanent, legible, and placed so that interference with the vision of the wearer is minimal. For a summary table of required markings see Annex G.

8.12.1 Frame Marking

Goggles, including the frame and lens housing or carrier, shall bear the manufacturer's identifying mark or symbol and shall be marked "Z87" indicating compliance with this standard.

8.12.2 Removable Lens Marking

Lenses shall be marked as follows:

Mark	Indication
Manufacturer	Manufacturers mark.
Z87	Complies with Basic Impact Testing Requirements of section 8.2.2.
Z87+	Complies with High Impact Testing Requirements of section 8.3.
Shade Number	Filter lens which complies with table 1.
S	Special Purpose lens, complies with table 2, but not with table 1.

V Photochromic lens.

8.12.2.1 Examples of Lens Marking

Assume that manufacturer "K" makes a Special Purpose lens which meets basic impact requirements. That lens would be marked as follows:

K Z87 S

Assume that manufacturer "W" makes a lens which meets the table 1 requirements of a shade 2.5 filter and meets high impact testing requirements. That lens would be marked as follows:

W Z87+ 2.5

Assume that manufacturer "Y" makes a clear lens which meets table 1 and high impact testing requirements. That lens would be marked as follows:

Y Z87+

8.12.3 Marking for products with Non-removable Lenses

Goggles with non-removable lenses shall require only one marking. This marking may be placed on the lens housing or the lens and shall consist of the manufacturer's identifying mark or symbol, "Z87" indicating compliance with this standard, a shade number if applicable and a "+" indicating that it meets the high impact testing requirements.

9 Faceshields

9.1 Introduction

Faceshields are protective devices designed to shield the wearer's face, or portions thereof, in addition to the eyes, from certain hazards. Faceshields shall be worn only in conjunction with spectacles or goggles.

9.2 Impact Testing Requirements

9.2.1 Faceshield Frame/Crown Tests

For the purpose of these tests, faceshield frames or crowns shall be equipped with test windows. A test window shall be capable of withstanding the specified test criteria without failure.

9.2.1.1 High Mass Impact

Faceshield frames or crowns shall be capable of resisting an impact from a pointed projectile weighing 500 g (17.6 oz) dropped from a height of 127 cm (50.0 in). The faceshield shall be tested in accordance with section 14.1. No piece shall be detached from the inner surface of any faceshield component and the window shall be retained in the frame.

9.2.1.2 High Velocity Impact

Faceshield frames or crowns shall be capable of resisting impact from a 6.35 mm (0.25 in) diameter steel ball traveling at a velocity of 91.4 m/s (300 ft/s). The faceshields shall be tested in accordance with section 14.2. No contact with the eye of the headform is permitted as a result of impact. No piece shall be detached from the inner surface of any faceshield component and the window shall be retained in the frame.

9.2.2 Basic Impact Window Tests

Removable windows shall be tested in the device in which they are designed to be used. Faceshields with lift-front type devices shall be tested for impact resistance with the lift-front in the up position.

9.2.2.1 Drop Ball Impact

Basic impact faceshield windows shall be capable of resisting impact from a 25.4 mm (1 in) diameter steel ball dropped from a height of 127 cm (50.0 in). The window shall be tested in accordance with section 14.4. The window shall not fracture as a result of this test. The window shall be retained in the frame.

9.2.2.2 Minimum Thickness

All faceshield windows shall be not less than 1.0 mm (.039 in) thick at their thinnest point, except glass, which shall be not less than 3.0 mm (.118 in) thick at its thinnest point.

9.2.2.3 Plastic Window Penetration Test

Plastic basic impact faceshield windows shall be capable of resisting penetration from a weighted projectile weighing 44.2 g (1.56 oz) dropped from a height of 127 cm (50.0 in) when tested in accordance with section 14.5. The window shall not fracture or be pierced through as a result of this test. No piece shall be detached from the inner surface of any faceshield component and the window shall be retained in the frame.

9.3 High Impact Testing Requirements

9.3.1 Faceshield Product Tests

For purposes of product testing, faceshields shall be tested as complete devices.

9.3.1.1 High Mass Impact

High impact faceshields shall be capable of resisting an impact from a pointed projectile weighing 500 g (17.6 oz) dropped from a height of 127 cm (50.0 in). The faceshield shall be tested in accordance with section 14.1. No piece shall be detached from the inner surface of any faceshield component and the window shall be retained in the frame. In addition, the window shall not fracture.

9.3.1.2 High Velocity Impact

High impact faceshields shall be capable of resisting impact from a 6.35 mm (0.25 in) diameter steel ball traveling at a velocity of 91.4 m/s (300 ft/s). The faceshields shall be tested in accordance with section 14.2. No contact with the eye of the headform is permitted as a result of impact. No piece shall be detached from the inner surface of any faceshield component and

the window shall be retained in the frame. In addition, the window shall not fracture.

9.3.1.3 Penetration Test

High impact faceshield windows shall be capable of resisting penetration from a weighted projectile weighing 44.2 gm (1.56 oz) dropped from a height of 127 cm (50.0 in) when tested in accordance with section 14.5. The window shall not fracture or be pierced through as a result of this test. No piece shall be detached from the inner surface of any faceshield component and the window shall be retained in the frame.

9.4 Optical Requirements for Plano Faceshield Windows

When tested alone, the lens/plate shall meet all optical requirements for plano faceshield windows.

9.4.1 Optical Qualities

The lenses shall be free of striae, bubbles, waves and other visible defects and flaws which would impair their optical quality.

9.4.2 Prismatic Power

Complete devices shall be tested in accordance with section 14.9. The prismatic power shall not exceed 0.37 Δ in any direction. Vertical prism imbalance shall not exceed 0.37 Δ, and horizontal prism imbalance shall not exceed 0.125 Δ "Base In" or 0.75 Δ "Base Out".

9.4.3 Resolving Power

Windows shall be tested for resolving power in accordance with section 14.10. All lines in both orientations of NBS Pattern 20 shall be clearly resolved.

9.4.4 Haze

Clear plano windows shall exhibit not more than 3% haze when tested in accordance with section 14.11.

9.4.5 Transmittance

Plano windows shall comply with the requirements specified in table 1 for clear and filter windows or table 2 for special purpose windows. Measurements shall be taken in accordance with section 14.12. Plano windows having transmittance values which meet the requirements of the table below shall be marked "light", "medium", or "dark". Special purpose windows having other luminous transmittance values are allowed, but shall not be marked light, medium, or dark.

Designation	Percent Luminous Transmittance
Light	50 +/- 7
Medium	23 +/- 4
Dark	14 +/- 4

9.5 Requirements for Wire-Screen Windows

Exposed borders of wire-screen windows and cut-outs in the wire-screen window (combination plastic and wire-screen) shall be suitably bound and otherwise finished in such a manner as to eliminate any sharp, rough, or unfinished edges. Wire-screen windows are exempt from 9.2.2.2 minimum thickness, 9.2.2.3 penetration test and 9.4 optical requirements.

9.6 Flammability

The headgear/adaptor, upper and lower crowns, and window shall be tested in accordance with

section 14.6. The material shall not burn at a rate greater than 76 mm (3 in) per minute.

9.7 Corrosion Resistance

Faceshields shall be tested in accordance with section 14.7. Metal components used in faceshields shall be corrosion resistant to the degree that the function of the faceshields shall not be impaired by the corrosion. Lenses and electrical components are excluded from these requirements.

9.8 Cleanability

Faceshields shall be capable of being cleaned in accordance with section 14.8. The function and markings of the faceshields shall not be impaired by the cleaning process.

9.9 Replacement Faceshield Windows

Since this standard allows for a great variety of faceshield window shapes, sizes, and retention systems, compliance with this standard cannot always be assured when replacement faceshield windows are used. Users shall exercise extreme care in the selection and installation of replacement faceshield windows. To ensure compliance with this standard all replacement faceshield windows shall be capable of meeting the same performance requirements as the replaced faceshield windows. Only those replacement faceshield windows designated by the faceshield window manufacturer to be compatible with a particular faceshield model shall be used as a component of that faceshield. This information shall be supplied with the replacement faceshield window(s).

9.10 Marking

All markings shall be permanent, legible, and placed so that interference with the vision of the wearer is minimal. For a summary table of required markings see Annex G.

9.10.1 Frame/Crown Marking

The faceshield, including the headgear/adapter and crown, shall bear the manufacturer's identifying mark or symbol and shall be marked "Z87" indicating compliance with this standard.

9.10.2 Window Marking

Windows shall be marked as follows:

Mark	Indication
Manufacturer	Manufacturers mark.
Z87	Complies with Basic Impact Testing Requirements, section 9.2.2.
Z87+	Complies with High Impact Testing Requirements, section 9.3.
Shade Number:	Filter windows, lenses or plates, which comply with table 1.
Light	Percent Luminous Transmittance: 50 +/- 7
Medium	Percent Luminous Transmittance: 23 +/- 4
Dark	Percent Luminous Transmittance: 14 +/- 4
S	Special Purpose windows, comply with table 2, but not with table 1, and do not fall within the luminous transmittance ranges of light, medium or dark.
V	Photochromic windows.

9.10.2.1 Examples of Windows Marking

Assume that manufacturer "K" makes a Special Purpose window, which meets basic impact requirements. That window would be marked as follows:

K Z87 S

Assume that manufacturer "W" makes a window, which meets the table 1 requirements of a shade 2.5 and meets high impact testing requirements. That window would be marked as follows:

W Z87+ 2.5

Assume that manufacturer "Y" makes a clear window which meets table 1 and high impact testing requirements. That window would be marked as follows:

Y Z87+

Assume that manufacturer "A" makes a window with a 23% luminous transmittance and meets basic impact requirements. That window would be marked as follows:

A Z87 Medium**9.10.3 Marking for products with Non-removable Lenses**

Faceshields with non-removable lenses shall require only one marking. This marking may be placed on the frame, crown, or window and shall consist of the manufacturer's identifying mark or symbol, "Z87" indicating compliance with this standard, a shade number if applicable and a "+" indicating that it meets the high impact testing requirements.

10 Welding Helmets and Handshields**10.1 Introduction**

Welding helmets and handshields are protective devices designed to provide protection for the eyes and face against optical radiation and weld spatter. Welding helmets shall be used only in conjunction with spectacles and/or goggles (see Selection Chart, Annex I - Attached at the end of the standard).

10.2 Impact Testing Requirements**10.2.1 Welding Helmet Shell Tests**

For the purpose of these tests, the welding helmet shall be equipped with a test lens. A test lens shall be capable of withstanding the specific test criteria without failure.

10.2.1.1 High Mass Impact

The welding helmet shell shall be capable of resisting an impact from a pointed projectile weighing 500 g (17.6 oz) dropped from a height of 127 cm (50.0 in). The welding helmet shall be tested in accordance with section 14.1. No piece shall be detached from the inner surface of any helmet component and the lens shall be retained in the helmet.

10.2.1.2 High Velocity Impact

The welding helmet shell shall be capable of resisting impact from a 6.35 mm (0.25 in) diameter steel ball traveling at a velocity of 45.7 m/s (150 ft/sec). The welding helmet shall be tested in accordance with section 14.2. No contact with the eye of the headform is permitted as a result of impact. No piece shall be detached from the inner surface of any helmet component and the lens shall be retained in the frame.

10.2.2 Basic Impact Lens Test

For the purpose of these tests, welding helmet lenses shall be tested individually.

10.2.2.1 Drop Ball Impact

Basic impact welding helmet lenses shall be capable of resisting the impacts specified below. The lens shall be tested in accordance with section 14.4. The lens shall not fracture as a result of this test.

Removable filter lenses shall be capable of resisting impact from a 15.9 mm (5/8 in) diameter steel ball, weighing 16 g (0.56 oz), dropped from a height of 1.0 m (39 in). If used, clear lenses, other than cover lenses, shall be capable of resisting impact from a 25.4 mm (1 in) diameter steel ball, weighing 68 g (2.4 oz), dropped from a height of 127 cm (50.0 in).

10.2.2.2 Plastic Lens Penetration Test

Basic impact plastic welding lenses shall be capable of resisting penetration from a weighted

projectile weighing 44.2 gm (1.56 oz) dropped from a height of 127 cm (50.0 in) when tested in accordance with section 14.5. The lens shall not fracture or be pierced through as a result of this test.

10.3 High Impact Testing Requirements

10.3.1 Welding Helmet Product Tests

For purposes of testing, welding helmets shall be tested as a complete device. Welding helmets with lift-fronts shall be tested for impact resistance and optical requirements with the lift-front in the "up" position.

10.3.1.1 High Mass Impact

High impact welding helmets shall be capable of resisting an impact from a pointed projectile weighing 500 g (17.6 oz) dropped from a height of 127 cm (50.0 in). The helmet shall be tested in accordance with section 14.1. No piece shall be detached from the inner surface of any helmet component and the lens shall be retained in the frame. In addition, the lens closest to the eye shall not fracture.

10.3.1.2 High Velocity Impact

High impact welding helmets shall be capable of resisting an impact from a 6.35 mm (0.25 in) diameter steel ball traveling at a velocity of 45.7 m/s (150 ft/s). The helmet shall be tested in accordance with section 14.2. No contact with an eye of the headform is permitted as a result of the impact. No piece shall be detached from the inner surface of any helmet component and the lens shall be retained in the frame. In addition, the lens closest to the eye shall not fracture.

10.3.1.3 Penetration Test

High impact plastic welding helmet lenses shall be capable of resisting penetration from a projectile weighing 44.2 g (1.56 oz.) dropped from a height of 127 cm (50 in) when tested in accordance with section 14.5. The lens closest

to the eye shall not fracture or be pierced through as a result of this test. No piece shall be detached from the inner surface of any helmet component and the lens shall be retained in the frame.

10.4 Optical Requirements for Plano Welding Helmet Lenses

When tested alone, the lens/plate of lift-fronts shall meet all optical requirements for plano welding helmet lenses.

10.4.1 Prismatic Power

Complete products shall be tested in accordance with section 14.9. Requirements for prism characteristics shall apply to all clear impact-resistant and filter lenses less than shade 9 (light state for autodarkening lenses). The prismatic power shall not exceed 0.50 Δ in any direction. Vertical prism imbalance shall not exceed 0.25 Δ , and horizontal prism imbalance shall not exceed 0.25 Δ "Base In" or 0.75 Δ "Base Out".

10.4.2 Refractive Power

Clear impact resistant lenses and filter lenses less than shade 9 (light state of autodarkening lenses) shall be tested in accordance with section 14.10. The refractive power, in any meridian, shall not exceed +/- 0.06 D. The maximum astigmatism, the absolute difference in power measured in the two extreme meridians, shall not exceed 0.06 D.

10.4.3 Resolving Power

Clear impact resistant lenses and filter lenses less than shade 9 (light state for autodarkening lenses) shall be tested for resolving power in accordance with section 14.10. All lines in both orientations of NBS Pattern 20 shall be clearly resolved. Lens/plates darker than shade 9 cannot see the target to resolve the lines.

10.4.4 Haze

Clear lenses shall exhibit not more than 3% haze

when tested in accordance with section 14.11.

10.4.5 Transmittance

Plano lenses shall comply with the requirements specified in table 1 or table 2. Measurements shall be taken in accordance with section 14.12.

10.5 Optical Requirements for Non-plano Welding Helmet Lenses

10.5.1 Optical Requirements

Non-plano helmet lenses shall comply with the optical requirements of ANSI Z80.1-1999.

10.5.2 Transmittance

Non-plano lenses shall comply with the requirements specified in either table 1 for clear or filter lenses, or table 2 for special purpose lenses. Measurements shall be taken in accordance with section 14.12. (Explanatory Note: Most non-plano lenses do not comply with the requirements of table 1. Those that cannot comply with table 1 would then be required to comply with table 2).

10.6 Flammability

The headgear, shell and lens housing or carrier shall be tested in accordance with section 14.6. The material shall not burn at a rate greater than 76 mm (3 in) per minute.

10.7 Corrosion Resistance

Welding helmets shall be tested in accordance with section 14.7. Metal components used in welding helmets shall be corrosion resistant to the degree that the function of the welding helmet shall not be impaired by the corrosion. Lenses and electrical components are excluded from these requirements.

10.8 Cleanability

Welding helmets shall be capable of being cleaned in accordance with section 14.8. The function and markings of the welding helmet

shall not be impaired by the cleaning process.

10.9 Non-Lens Area Transmittance and Light Tightness

10.9.1 Transmittance of Non-Lens Areas

When tested in accordance with section 14.12, non-lens areas of welding helmets with removable lenses shall transmit no more optical radiation than that permitted by table 1 for shade number 14. Non-lens areas of welding helmets with non-removable lenses shall transmit no more optical radiation than that of the lens.

10.9.2 Light Tightness

All non-lens areas of welding helmets shall prevent the direct penetration of visible light. No direct visible light shall enter between the lens and the lens holder when tested in accordance with section 14.14.

10.10 Replacement Welding Helmet Lenses

Since this standard allows for a great variety of welding helmet shapes, sizes, and retention systems, compliance with this standard cannot always be assured when replacement lenses are used. Users shall exercise extreme care in the selection and installation of replacement lenses. To ensure compliance with this standard all replacement lenses shall be capable of meeting the same performance requirements as the replaced lenses. Except for 51 x 108 mm (2.00 x 4.25 in) or 114 x 133 mm (4.50 x 5.25 in) rectangular lenses, only those replacement lenses designated by the lens manufacturer to be compatible with a particular welding helmet model shall be used as a component of that welding helmet. This information shall be supplied with the replacement lens(es). See Section 9.2.2.2 for minimum thickness requirements.

51 x 108 mm (2.00 x 4.25 in) and 114 x 133 mm (4.50 x 5.25 in) rectangular lenses shall have a dimensional tolerance of: Rectangular +/- 0.8 mm (0.031 in).

10.11 Marking

All markings shall be permanent, legible, and placed so that interference with the vision of the wearer is minimal. For a summary table of required markings see Annex G.

10.11.1 Welding Helmet Marking

The welding helmet, including the headgear, shell and lens housing or carrier, shall bear the manufacturer's identifying mark or symbol and shall be marked "Z87" indicating compliance with this standard.

10.11.2 Removable Lens Marking

Lenses shall be marked as follows (cover lenses are excluded):

Mark	Indication
Manufacturer	Manufacturers mark.
Z87	Complies with Basic Testing Requirements of section 10.2.2.
Z87+	Complies with High Impact Testing Requirements of section 10.3.
Shade Number	Filter lens, which complies with table 1.
S	Special Purpose lens, complies with table 2, but not with table 1.
V	Photochromic lens.

10.11.2.1 Examples of Lens Marking

Assume that manufacturer "K" makes a Special Purpose lens which meets basic impact requirements. That lens would be marked as follows:

K Z87 S

Assume that manufacturer "W" makes a lens which meets the table 1 requirements of a shade

2.5 filter and meets high impact testing requirements. That lens would be marked as follows:

W Z87+ 2.5

Assume that manufacturer "Y" makes a clear lens which meets table 1 and high impact testing requirements. That lens would be marked as follows:

Y Z87+

10.11.3 Markings for Products with Non-Removable Lenses

Welding helmets with non-removable lenses shall require only one marking. This marking may be placed on the shell, lens housing or the lens and shall consist of the manufacturer's identifying mark or symbol, "Z87" indicating compliance with this standard, a shade number if applicable and a "+" indicating that it meets the high impact testing requirements.

10.12 Transmittance Requirement-Automatic Darkening Welding Filter Lenses

UV and IR filters shall be assembled within the automatic darkening welding filter lens assembly in such a manner that they are not removable by the user.

10.12.1 Dark State Transmittance, Automatic Darkening Welding Filter Lenses

Automatic darkening welding filter lenses shall comply with the luminous transmittance requirements specified in table 1 when tested in each designated dark shade number in accordance with section 14.12. Tests shall be performed at temperatures of -5°C +/- 2°C (23°F +/- 3.6°F), 23°C +/- 2°C (73.4°F +/- 3.6°F), and 55°C +/- 2°C (131°F +/- 3.6°F).

10.12.2 Additional Requirements for Automatic Darkening Welding Filter Lenses

Automatic darkening welding filter lenses shall meet all requirements of section 10 with the

exception of sections 10.7, Corrosion Resistance, and 10.8, Cleanability.

10.12.3 UV and IR Transmittance

Automatic darkening welding filter lenses shall be tested in accordance with section 14.12. The test specimen shall meet the requirements for UV and IR transmittance as specified in table 1 for its designated dark shade number. An adjustable shade lens shall meet the table 1 requirement for its highest designated dark shade number. The test specimen shall be tested in the dark state, light state and unpowered at a temperature of $23^{\circ}\text{C} \pm 2^{\circ}\text{C}$ ($73.4^{\circ}\text{F} \pm 3.6^{\circ}\text{F}$).

10.12.4 Switching Index

An automatic darkening welding filter lens shall be tested in accordance with section 14.13 and shall meet the requirements of table 3 when tested at temperatures of $-5^{\circ}\text{C} \pm 2^{\circ}\text{C}$ ($23^{\circ}\text{F} \pm 3.6^{\circ}\text{F}$), $23^{\circ}\text{C} \pm 2^{\circ}\text{C}$ ($73.4^{\circ}\text{F} \pm 3.6^{\circ}\text{F}$), and $55^{\circ}\text{C} \pm 2^{\circ}\text{C}$ ($131^{\circ}\text{F} \pm 3.6^{\circ}\text{F}$).

10.12.5 Occlusion

All but any one sensor of the automatic darkening welding filter lenses shall be occluded with an opaque material. The filter shall then be tested in accordance with section 14.13 and, other than in the case of a complete failure to switch, shall meet the requirements of table 3 when tested at temperatures of $-5^{\circ}\text{C} \pm 2^{\circ}\text{C}$ ($23^{\circ}\text{F} \pm 3.6^{\circ}\text{F}$), $23^{\circ}\text{C} \pm 2^{\circ}\text{C}$ ($73.4^{\circ}\text{F} \pm 3.6^{\circ}\text{F}$), and $55^{\circ}\text{C} \pm 2^{\circ}\text{C}$ ($131^{\circ}\text{F} \pm 3.6^{\circ}\text{F}$). The unit shall meet these requirements regardless of which sensor or sensors are occluded.

10.13 Cover Lenses

Cover lenses are exempt from all requirements of this standard. Cover lenses do not provide protection from optical radiation or impact. Cover lenses shall not be marked "Z87".

11 Respirators

11.1 Introduction

Full facepiece and loose fitting respirators are protective devices designed to provide respiratory and eye protection from certain hazards. Loose fitting respirators may also offer head protection against impact and penetration.

Note: Where loose fitting respirators are moved from the normal position during use, then they shall be used only in conjunction with spectacles or goggles.

11.2 Full Facepiece Respirators

For the purposes of product testing, a full facepiece respirator shall be tested as a complete goggle and shall meet the requirements of sections 8.3 through 8.10.

11.3 Loose Fitting Respirators

For the purposes of product testing, a loose fitting respirator shall be tested as a complete faceshield and shall meet the requirements of sections 9.3 through 9.10.

11.4 Full Facepiece Welding Respirators

For the purposes of product testing, a full facepiece welding respirator shall be tested as a complete welding goggle and shall meet the requirements of sections 8.3 through 8.10. In addition, welding respirators using shade 8 or higher filters shall meet the requirements of sections 10.4 through 10.13.

11.5 Loose Fitting Welding Respirator

For the purposes of product testing, a loose fitting welding respirator shall be tested as a complete welding helmet and shall meet the requirements of sections 10.3 through 10.13.

12 Transmittance Requirements for Clear Lenses, Filter Lenses and Automatic Darkening Filter Lenses

12.1 Formulae

1. Shade Number, S, is related to luminous transmittance, T_L , (expressed as a fraction, not as a percent) by the equation:

$$S = \frac{7}{3} \text{Log}_{10} \frac{1}{T_L} + 1$$

2. When $T(\lambda)$ is defined as the spectral transmittance of the filter at wavelength, the effective far-ultraviolet average transmittance, \bar{T} (EFUV), is defined as:

$$\bar{T} (EFUV) = \frac{\int_{200}^{315} T(\lambda)W(\lambda)d\lambda}{\int_{200}^{315} W(\lambda)d\lambda}$$

where $W(\lambda)$ is the Spectral Weighting Factor given in table A1 of annex A.

3. The near-ultraviolet average transmittance is defined as:

$$\bar{T} (NUV) = \frac{1}{65} \int_{315}^{380} T(\lambda)d\lambda$$

4. The luminous transmittance, T_L , is defined in this standard with respect to the light source CIE Illuminant A and the CIE 1931 Standard Colorimetric Observer, and is expressed as:

$$T_L = \frac{\int_{380}^{780} T(\lambda)\bar{y}(\lambda)S(\lambda)d\lambda}{\int_{380}^{780} \bar{y}(\lambda)S(\lambda)d\lambda}$$

where $\bar{y}(\lambda)$ is the relative luminous efficiency function and $S(\lambda)$ is the relative spectral emittance of Illuminant A as defined by the CIE. These functions are given in table A2 of annex A.

5. The infrared average transmittance, \bar{T} (IR), is defined as:

$$\bar{T} (IR) = \frac{\int_{780}^{2000} T(\lambda)S(\lambda)d\lambda}{\int_{780}^{2000} S(\lambda)d\lambda}$$

where, in the infrared, the relative spectral emittance $S(\lambda)$ of Illuminant A is that of a full ("Black-body") radiator at temperature 2856 K and is given in table A3 of annex A.

6. The blue-light transmittance, T_B , is defined as:

$$T_B = \frac{\int_{400}^{1400} T(\lambda)B(\lambda)d\lambda}{\int_{400}^{1400} B(\lambda)d\lambda}$$

where $B(\lambda)$ is the Blue-Light Hazard Function defined in table A4 of annex A.

7. Switching Index is defined as:

$$\text{SwitchingIndex} = \frac{1}{T_1} \int_{t=0}^{t=3T_2} T(t)dt$$

where: $t = 0$ is the time at which the arc ignites, T_1 is the designated light state, T_2 is the designated dark state, $t[3T_2]$ is the time at which the luminous transmittance falls to three times the luminous transmittance in the dark state.

Note: In the case of short term exposure to light, the glare is approximately proportional to the product of the illuminance at the eye and time. The time dependence of the darkening process can differ for different designs of filters where the luminous transmittance varies with time. It is therefore appropriate to define the response time of an automatic darkening filter lens as an integral of the luminous transmittance over time and not merely by the initial and final luminous transmittance.

12.2 Transmittance Requirements

Requirements for transmittance are given in tables 1 and 2 and the notes which immediately follow each table.

TABLE 1
Transmittance Requirements for Clear Lenses
and General-Purpose Filters

Shade Number	Luminous Transmittance			Maximum Effective Far-Ultraviolet Average Transmittance %	Maximum Infrared Average Transmittance %
	Maximum %	Nominal %	Minimum %		
CLEAR	100	-	85	-	-
1.3	85	74.5	67	0.1	<30
1.5	67	61.5	55	0.1	25
1.7	55	50.1	43	0.1	20
2.0	43	37.3	29	0.1	15
2.5	29	22.8	18.0	0.1	12
3.0	18.0	13.9	8.50	0.07	9.0
4	8.50	5.18	3.16	0.04	5.0
5	3.16	1.93	1.18	0.02	2.5
6	1.18	0.72	0.44	0.01	1.5
7	0.44	0.27	0.164	0.007	1.3
8	0.164	0.100	0.061	0.004	1.0
9	0.061	0.037	0.023	0.002	0.8
10	0.023	0.0139	0.0085	0.001	0.6
11	0.0085	0.0052	0.0032	0.0007	0.5
12	0.0032	0.0019	0.0012	0.0004	0.5
13	0.0012	0.00072	0.00044	0.0002	0.4
14	0.00044	0.00027	0.00016	0.0001	0.3

Notes:

- (1) The near-ultraviolet average transmittance shall be less than one tenth of the minimum allowable luminous transmittance except for clear lenses.
- (2) The blue light transmittance shall be less than the luminous transmittance except for clear lenses.
- (3) Clear and shaded plano lenses shall comply with the requirements specified in table 1. Measurements shall be taken according to section 14.12. For Shades 1.3 through 3.0, the ratio of the two measured transmittances, one for each lens of a removable pair, or at points directly in front of each eye for a non-removable lens shall not be less than 0.90, nor more than 1.10. For shades 4 through 14 inclusive, the ratio of the two measured transmittances, shall be not less than 0.80, nor more than 1.25.
- (4) Filters are typically, but not exclusively, used for welding. Refer to 6.2.4.3 for additional information.
- (5) Clear is excluded as a shade number. Shade numbers in practice refer to transmissions for filters, and tinted lenses as defined in Table 2.

Table 2 - Transmittance Requirements for Special-Purpose Lenses

LUMINOUS TRANSMITTANCE

LENS TYPE	% MAXIMUM	% MINIMUM	*RATIO [R] of measured Luminous Transmittance
Tinted	100	8	$0.90 < R < 1.10$
Extra Dark	<8	0.2	$0.8 \leq R \leq 1.20$

*R is the ratio of the two measured transmittances, one for each lens of a pair, or at points directly in front of each eye for a single lens.

Lenses meeting table 2 requirements may not provide UV or IR protection and wearers could be exposed to potentially harmful levels of radiation. Due to the filtering nature of tinted lenses, wearers could be exposed to increased levels of UV and IR radiation due to pupillary dilation.

Wearers should be cautioned that tinted lenses are typically designed for use for specific visual tasks. Care should be used in their selection and use, especially where color recognition is important, i.e. traffic signals, electrical wire splicing, visual displays, etc. Some tinted lenses can alter color perception.

12.3 Switching Index Requirements.

Table 3 - Switching Index Requirements for Automatic Darkening Welding Filter Lenses

LIGHT SHADE NUMBER

	1.7	2	2.5	3	4	5	6
DARK SHADE NUMBER	Switching	Index (ms)					
7	300	400	500	700	1000	-	-
8	100	150	200	300	500	1000	-
9	40	50	70	100	200	400	700
10	20	20	30	40	70	100	300
11	6	7	10	15	30	50	100
12	2	3	4	5	10	20	40
13	0.8	1	1.5	2	4	7	10
14	0.3	0.4	0.5	0.7	1	3	5

13 Instructions, Use and Maintenance

13.1 General Requirements

Eye and face protection shall be required where there is a reasonable probability of injury that can be prevented by such equipment. In such cases, employers and educational authorities shall make conveniently available a protective device for the work environment, per applicable federal and state regulations. Employees and students shall use such device.

Annex I contains a Selection Chart, which will be helpful in deciding types of protective devices that are available, their capabilities and limitations. It should be recognized that dusty or chemical environments, or both might represent an additional hazard to contact lens wearers. Wearers of contact lenses shall be required to wear appropriate eye and face protection devices in a hazardous environment.

13.2 Instructions

Employers and educational authorities shall provide employees and students with all warnings, cautions, instructions and limitations provided with the protector by the manufacturer and inform wearers as to their meaning.

13.3 Inspections

Employees and students shall make a visual inspection of their protector prior to each use. Protective devices, which exhibit broken parts, distortion, or excessive scratches on the lens, are unsuitable for use and shall not be worn. Eye and face protective devices that have been subject to an impact shall not be used and shall be discarded.

13.4 Maintenance

Protectors shall be maintained in a usable condition in accordance with the manufacturers instructions.

When one protector is being used by more than one person, it is recommended that it be cleaned and disinfected prior to use by another person.

13.5 Care

Reasonable care shall be taken during the use and storage of protectors so that they are not subject to unnecessary abuse.

13.6 Training

Employers and educational authorities shall train employees and students in the proper use, application, inspection, maintenance, storage, and limitations of protective devices.

14 Test Methods

Unless otherwise specified, all tests shall be performed at normal laboratory ambient conditions. In many tests the Alderson 50th percentile male headform is specified; if, however, a product is designed to fit a larger or smaller group of the population, then the Alderson 95th percentile male or 5th percentile female headforms should be used. Appropriate eye and face protection shall be worn for all impact and penetration tests.

Impact test methods are all type tests except for drop ball tests for non-plano spectacle lenses (section 14.4.2.1) (see 7.3.1). The frequency of repeating the type tests should be in conformance to the manufacturer's quality assurance protocol.

Statistical sampling is an acceptable means of demonstrating compliance with the performance criteria of sections 7 through 11. This standard does not require the use of a specific sampling plan, however, the plan chosen must be statistically significant. An example of an acceptable plan is ANSI/AQC Z1.4-1993.

Alternative test methods and apparatus to those cited in this standard may be used if equivalent results can be demonstrated. In case of dispute, the methods and apparatus cited in this standard shall take precedence.

14.1 High Mass Impact Test

14.1.1 Purpose

This test is intended to determine the capability of a protector to resist impact from relatively heavy, pointed objects traveling at low velocity.

14.1.2 Apparatus

An Alderson 50th percentile male headform shall be used to hold the protective device. It shall be rigidly mounted in the horizontal position, face up, on a base which has a mass of 30 kg (66 lb) or greater. The static stiffness of the headform shall be such that when a vertical downward force of 20 kg (44 lb) is applied to the forehead of the headform, the back of the headform shall not deflect more than 2 mm (0.08 in). The missile shall be made of steel and shall have a 30° conical tip with a 1 mm (0.04 in) spherical radius, shall weigh 500 g (17.6 oz), and have a diameter of 25.4 mm (1.0 in), as shown in figure C4. The missile will be held in position over the headform, tip down, at the designated test height. The missile may have a hardened steel tip. Care shall be taken to maintain the tip configuration and weight of the missile.

The missile shall be dropped through a loose-fitting guide tube having a smooth internal diameter; this prevents missile tumble while not retarding free fall. Shielding around the headform is required to protect the operator.

14.1.3 Procedure

The protective device is placed on the headform as it was designed to be worn. The alignment shall be such that when the missile is dropped, its point is in line with the center of either of the eyes of the headform.

The missile shall be dropped from a height of 127 cm (50.0 in) measured from the conical tip of the missile to the impact point of the protector. To protect the operator, the guide tube shall be positioned so that the lower end of the tube is 180 mm (7.1 in) from the point of impact. Four

devices shall be tested, two on the left viewing area and two on the right viewing area.

14.1.4 Analysis of Results

Failure criteria are given in sections 7 through 11 for the particular type of device being tested. Examine the device for evidence of pieces missing from the inner surface of the device. Examine the lens(es) closest to the eye for evidence of fracture, or displacement from the frame. If any of the criteria are not met, then the device fails.

14.2 High Velocity Impact Test

14.2.1 Purpose

This test is intended to determine the capability of a protector to resist impact from high velocity, low mass projectiles.

14.2.2 Apparatus

The test apparatus shall consist of an Alderson 50th percentile male headform mounted vertically within an enclosure and a device capable of propelling a 6.35 mm (0.25 in) steel ball weighing 1.06 g (0.037 oz) reproducibly at velocities from 45.7 to 91.4 m/s (150 to 300 ft/s) at the headform. The path of the projectile shall be on a horizontal reference plane formed by the center of the eyes of the headform.

The headform shall be capable of being rotated about the vertical axis specified in 14.2.3 in 15° increments, from a first position 15° to the nasal side of straight-ahead-viewing out to 90° temporally. The headform shall be capable of being raised 10 mm (0.394 in) and lowered 10 mm (0.394 in) with respect to the horizontal reference plane to carry out testing at the 90° angular position. Mass of the test headform shall be at least 4 kg (8.8 lb).

The velocity of the steel ball shall be determined at a distance not greater than 25 cm (9.8 in) from the eye of the headform and shall have a standard deviation not exceeding 2% of the

specified test velocity over a test series of 30 shots.

Some form of containment shall surround the headform to prevent debris or the ricocheting projectile from endangering observers. Steel balls traveling at high speeds can be lethal. Therefore, they shall be contained within the test apparatus by appropriate engineering controls to prevent injury or death.

Information about a typical High Velocity Impact Test Apparatus is given in annexes C and E.

14.2.3 Procedure

Apply a thin layer of white contact paste to each of the eyes of the headform covering an area 25 mm (1.0 in) in diameter centered on the corneal vertex of the eye. The protective device shall be mounted on the headform in the manner in which the device was designed to be worn. The headform shall be adjusted so that the path of the projectile passes through the center of the anterior surface of either of the eyes of the headform. The headform is then rotated on an axis, which passes vertically at their intersection of a sagittal plane through the center of the front surface of the tested eye and a coronal (frontal) plane which is 10 mm posterior to the corneal plane which is tangent to the anterior surfaces of the eyes of the headform, to the first test position, which is 15° on the nasal side. The device is impacted at the test velocity. The balls are damaged during impact and should be changed frequently to avoid impacts at unexpected locations and large variations in velocity.

A new device is then placed on the headform and impacted at 0°, another is impacted at 15° temporally, and so on, until eight devices have been impacted in the horizontal plane of the center of the eyes of the headform, with each impact centered on the axis of rotation which lies 10 mm posterior to the center of the anterior surface of the test eye of the headform. At the 90° angular position, one device shall be impacted 10 mm (0.394 in) above the plane of

the eyes of the headform, and another device shall be impacted 10 mm (0.394 in) below the plane of the eyes of the headform. The total group size tested about one eye is ten devices with one impact each at 15° nasal, 0°, 15°, 30°, 45°, 60°, 75° temporal, and 3 impacts 90° temporal. A similar test is then carried out about the other eye, resulting in a total of twenty devices tested.

14.2.4 Testing Spectacles Without Side Protection

When testing spectacles without side protection, one proceeds as in 14.2.3 until reaching the angle where the lens or front is no longer impacted. Starting back at the 15° nasal position on the same side, additional samples should be tested at 15° nasal, 0°, 15° temporal. A similar procedure is then carried out on the other side of the headform.

14.2.5 Analysis of Results

Failure criteria are given in sections 7 through 11, excluding non-plano high impact lenses, which are covered by Section 14.3, for the particular type of device being tested. Examine the headform for pieces of the protector adhering to the contact paste. Examine the device for evidence of pieces missing from the inner surface of the device. Examine the protector and the ball for any contact paste. Adherence of pieces to the contact paste or contact paste on the ball or protector is evidence of a failure. Examine the lens(es) closest to the eye for evidence of fracture. If any fail, the device fails.

14.3 Test for High Impact Prescription Lenses

Plano power lenses, maximum base curve of 6.25, shall be edged round with an industrial safety bevel to a diameter 55.0 mm +0.04 mm/-0.25 mm. Each lens shall be tested once, with a new lens used for each additional impact. Each lens shall be mounted in the test holder (see figure B3) by two retaining washers so that the test lens is held firmly against the bevel of the

lens holder. Perform the high velocity impact test on the center of each lens with the missile specified in 14.2 at a velocity of 45.7 m/s (150 ft/sec.).

Repeat the test with 2 additional sample lenses, giving a total of three test lenses. Failure consists of any posterior displacement of the lens completely through the test holder; any fracture of the lens; any detachment of a portion of the lens from its inner surface; or any full thickness penetration of a lens. Failure of any lens constitutes a failure. If all test lenses pass, then any prescription lens of the same or greater thickness at its thinnest point, which is made by the same manufacturer, from the same material, with the same coatings and processes may bear the "+" mark.

14.4 Drop-Ball Impact Test

14.4.1 Purpose

These tests are intended to ensure that various types of lenses possess levels of impact resistance equal to those meeting requirements of the previous ANSI Z87.1 standard when tested with the traditional drop-ball impactor.

14.4.2 Test Sample Sizes

Four devices shall be tested except for non-plano spectacle lenses, (see Section 7.3.1).

14.4.2.1 Removable Spectacle Lenses

For testing removable spectacle lenses, the lens shall be removed from the frame and placed mechanically centered, convex side up, on the test block of an anvil composed of the parts shown in figure B1, mounted in the hole of the base plate shown in figure B2, the whole assembly on a flat, horizontal work surface of convenient height. A 25.4 mm (1 in) diameter steel ball, weighing 68 g (2.4 oz), shall be dropped in free fall from a height of 127 cm (50 in) onto the horizontal outer surface of the lens, perpendicularly impinging on the lens within a circular area of 16 mm (0.63 in) diameter centered at the lens mechanical center.

14.4.2.2 Round, Removable Goggle Lenses

For testing round, removable goggle lenses, the lens shall be removed from the eyecup and placed flat on the end of a wooden tube having an internal diameter of 45mm (1.77 in) and a rim to fit the lens. A washer of neoprene rubber of a 40 +/-5 durometer Shore A reading, not more than 3.2 mm (1/8 in) thick, and of the same size as the end diameter of the tube, shall be placed between the lens and the tube. A steel ball shall be freely dropped from a height of 127 cm (50 in) onto the horizontal outer surface of the lens. Clear lenses and filter lenses with shade numbers up to and including shade 3 shall be tested with a 25.4 mm (1.0 in) diameter steel ball weighing 68 g (2.4 oz). Filter lenses of shades higher than 3 shall be tested with a 22 mm (7/8 in) diameter steel ball weighing 44.2 g (1.56 oz).

14.4.2.3 Rectangular, Removable Goggle and Welding Helmet Lenses

For testing removable, rectangular goggle and welding helmet lenses, a suitable rigid frame not less than 20 mm (0.81 in) in height is required. The support frame shall provide a 6.4 mm (0.25 in) support around the periphery of the lens to be tested. A washer of neoprene rubber of a 40 +/-5 durometer Shore A reading, not more than 3.2 mm (0.125 in) thick, and of the same internal dimensions as the supporting surface, shall be placed between the lens and the support.

For rectangular goggle lenses, a 22 mm (7/8 in) diameter steel ball weighing 44.2 g (1.56 oz) shall be freely dropped from a height of 1.0 m (39 in) onto the center of the horizontal outer surface of the lens.

For welding helmets, a 15.9 mm (5/8 in) diameter steel ball weighing 16 g (0.56 oz) shall be freely dropped from a height of 1.0 m (39 in) onto the center of the horizontal surface of the lens. For welding helmet clear lenses (not cover lenses, see 10.13), a 25.44 mm (1 in) diameter steel ball weighing 68 g (2.4 oz) shall be freely

dropped from a height of 127 cm (50 in) onto the center of the horizontal outer surface of the lens.

14.4.2.4 Removable Faceshield Lens

A faceshield with the removable lens shall be put on an Alderson 50th percentile male headform as described in section 14.1.2. An additional supporting block, approximately 25.4 mm (1.0 in) wide and curved to conform to the shape of the faceshield shall be provided as a support for the faceshield at its lower end but not lower than the chin of the headform. The headform is positioned so that the axis of the faceshield is horizontal and the outer surface of the window is facing upward. A 25.4 mm (1 in) diameter steel ball, weighing 68 g (2.4 oz) shall be freely dropped from a height of 127 cm (50 in) onto the apex of the window at a point in line with the eyes of the headform.

14.4.2.5 Other Devices

For testing all other devices, an Alderson 50th percentile male headform as described in section 14.1.2 is required.

For all devices with non-removable lenses, the device shall be placed on the headform of the High Mass Impact Test Apparatus (Section 14.1) as it would be worn by the user. The alignment shall be such that when the ball is dropped, it is in line with either of the eyes of the headform.

14.4.3 Analysis of Results

Failure criteria are given in Sections 7 through 11 for the particular type of device being tested. Examine the device for evidence of fracture or penetration. The device fails if any evidence of fracture or penetration is seen.

14.5 Penetration Test.

14.5.1 Purpose

This test is intended to determine the capability of a plastic lens to resist penetration by a low mass pointed projectile.

14.5.2 Apparatus

The test apparatus shall consist of a pointed projectile consisting of a new 135 x 17 needle fastened into a holder, weighing 44.2 g (1.56 oz). The projectile shall be dropped through a loose-fitting guide tube having a smooth internal diameter; this prevents projectile tumble while not retarding free fall.

For testing removable spectacle lenses, a test block, as shown in figure B1, mounted in the hole of a base plate, as shown in figure B2, is required.

For testing removable goggle and welding helmet lenses, a rigid frame not less than 20 mm (0.81 in) in height is required. The support frame shall provide a 6.4 mm (0.25 in) support around the periphery of the lens to be tested. A washer of neoprene rubber of a 40+/-5 durometer Shore A reading, not more than 3.2 mm (0.125 in) thick, and of the same internal dimensions as the support, shall be placed between the lens and the support.

For testing all other devices an Alderson 50th percentile male headform as described in section 14.1.2 is required. For faceshields, an additional supporting block, approximately 25.4 mm (1.0 in) wide and curved to conform to the shape of the window, shall be provided as a support for the window at its lower end but not lower than the chin of the headform.

14.5.3 Procedure

The projectile shall be freely dropped through the guide tube, point downward, from a height of 127 cm (50 in) onto the horizontal outer surface of the lens. Four devices shall be tested. To protect the operator, the guide tube shall be positioned so that the lower end of the tube is 102 mm (4.0 in) from the point of impact.

For removable lenses, the lens shall be removed from the frame and placed mechanically centered, convex side up, on the test block as described in section 14.4.2.

For faceshields, the window shall be placed in a horizontal position such that the axis of the window is horizontal and the outer surface of the window is facing upward. The projectile shall be dropped onto the apex of the window at a point in line with the eyes of the headform.

For all devices with non-removable lenses, the device shall be placed on the headform of the High Mass Impact Test Apparatus (section 14.1) as it would be worn by the user. The alignment shall be such that when the projectile is dropped, its point is in line with either of the eyes of the headform.

14.5.4 Analysis of Results

Failure criteria are given in sections 7 through 11, for the particular type of device being tested. Examine the device for evidence of fracture or penetration. The device fails if any evidence of fracture or penetration is seen.

14.6 Flammability Test

14.6.1 Purpose

This test is intended to measure the rate of burning or extent of burning of plastics used in protectors.

14.6.2 Apparatus and Procedure

The apparatus and procedure as specified in ASTM test method D635-1998 shall be used to evaluate the flammability of plastic components. Alternatively, certification of the materials used provided by the source of supply is acceptable.

14.6.3 Analysis of Results

Failure criteria are given in sections 7 through 11 for the particular type of device being tested.

14.7 Corrosion Resistance Test

14.7.1 Purpose

This test is intended to determine the capability of metal components of a protector to resist corrosion.

14.7.2 Apparatus

The test apparatus shall consist of a boiling saline solution and a room temperature saline solution both in containers of sufficient dimensions to submerge the metal parts. The saline solutions shall contain 10% by weight of sodium chloride in water.

14.7.3 Procedure

Metal parts shall be submersed in the boiling saline solution for a period of fifteen minutes. The parts, upon being removed from the boiling solution, shall be immediately immersed in the room temperature saline solution. They shall then be removed from this solution, and without having the adhering liquid wiped off, allowed to dry for twenty-four hours at room temperature. The metal parts shall then be rinsed in lukewarm water and allowed to dry.

14.7.4 Analysis of Results

Failure criteria are given in sections 7 through 11 for the particular type of device being tested. Examine the device for functional impairment.

14.8 Cleanability Test

14.8.1 Purpose

This test is intended to determine the capability of a protector to withstand cleaning.

14.8.2 Apparatus and Procedure

Products shall be cleaned in accordance with the manufacturer's instructions. If none are available, clean with mild soap and warm water solution by soaking the device in the soap solution maintained at 43°C - 49°C (110 - 120°F)

for ten minutes. Rinse thoroughly and allow to air dry.

14.8.3 Analysis of Results

Failure criteria are given in sections 7 through 11 for the particular type of device being tested. Examine the device following the test cleaning process for functional impairment.

14.9 Prismatic Power Test

14.9.1 Purpose

This test is intended to measure the prismatic power and prismatic imbalance of a protector.

14.9.2 Apparatus

This apparatus shall consist of an Alderson 50th percentile male headform which has been modified by boring two through holes at least 19.0 mm (0.75 in) diameter centered on each eye. The headform shall be placed in an optical system as shown in figure C6. The telescope lens, L2, shall be located at a distance of 1.0 m (39.4 in) in front of image plane, IP. The pinhole aperture plate, p, shall be located approximately 1.0 m (39.4 in) from the collimator lens, L1, and shall be adjusted so that one image is formed on the image plane, IP, when no protector is on the headform. The position of that image shall be marked or noted and will be called Po.

14.9.3 Procedure

The protective device shall be placed on the headform in the designed wearing position, without having changed the spacing of the optical system. The image(s) on the image plane shall be identified as coming from the right eye, Pr, or the left eye, Pl, by blocking the beams of each eye. The distance in centimeters between the centers of Pl and Po and Pr and Po shall be measured. The prismatic power of the protector in prism diopters (Δ) is determined by measuring the distance in centimeters between Po and Pl or Po and Pr, whichever is greater.

The horizontal and vertical distances in centimeters between the centers of Pl and Pr shall be measured.

The horizontal prism imbalance of the protector in prism diopters shall be the horizontal distance measured in centimeters between Pl and Pr. The vertical prism imbalance of the protector in prism diopters shall be the vertical distance measured in centimeters between Pl and Pr. The "base" of the horizontal prism imbalance shall be determined by looking at the image plane (looking at the image plane from the headform). If the right-most image comes from the right eye of the headform, then the prism imbalance is "base out". If the left-most image comes from the right eye of the headform, then the prism imbalance is "base in".

14.9.4 Analysis of Results

Failure criteria are given in sections 7 through 11 for the particular type of device being tested.

14.10 Refractive Power, Resolving Power and Astigmatism Tests

14.10.1 Purpose

These tests are intended to determine that the protectors meet the optical requirements for refractive power, astigmatism and resolving power of this standard.

14.10.2 Apparatus

The apparatus shall consist of a calibrated 8 power telescope having a minimum aperture of 19 mm, a means of holding the protector in the test position, a sunburst test pattern, figure C5, and a high contrast test pattern from NBS Special Publication 374, (See annex E for source). The test patterns shall be interchangeable and mounted 10.67 m (35 ft) from the objective lens of the telescope. Calibration methods for the telescope are given in annex D.

14.10.3 Procedure

The telescope and observer shall be qualified by resolving pattern 40 of the high contrast test pattern when no lens is in front of the telescope. The telescope shall then be focused on the sunburst test pattern (See Annex C). The lens to be tested shall be positioned with the primary line of sight coincident with the axis of the telescope.

The distance between the lens being tested and the objective lens of the telescope shall not exceed 38 mm (1.5 in). The telescope is then re-focused on the radial lines until they appear as sharp as possible. Two possibilities may then occur, all or just some of the lines will appear well focused.

If all radial lines appear equally well-focused at the same position of the focus wheel, the lens has no measurable astigmatism and the power reading of the telescope is the refractive power of the test lens.

If lines in only one meridian appear sharpest at a given focus, then the telescope shall be re-focused to determine the best focus for the lines in the meridian which yield an extreme (maximum or minimum) power reading. The power reading shall be noted. The telescope shall be then re-focused for lines in the meridian which yields the opposite extreme power reading. The second power reading shall be noted. The astigmatism shall be calculated as the absolute value of the algebraic difference between the two extreme power readings.

The telescope shall then be re-focused for the best compromise focus, that is, until all radial lines appear equally sharp. The sunburst test pattern shall be replaced with the high contrast test pattern. The observer shall attempt to resolve all lines of pattern 20 in both orientations without re-focusing the telescope.

14.10.4 Analysis of Results

Failure criteria are given in sections 7 through 11 for the particular type of device being tested.

14.11 Haze Test

14.11.1 Purpose

This test is intended to measure the haze in clear lenses.

14.11.2 Apparatus and Procedure

The apparatus and procedures specified in ASTM D1003-00, *Test Method for Haze and Luminous Transmittance of Transparent Plastics*, shall be used to measure the haze. The illuminant used shall be CIE illuminant A.

14.11.3 Analysis of Results

Failure criteria are given in sections 7 through 11 for the particular type of device being tested.

14.12 Transmittance Test

14.12.1 Purpose

This test is intended to measure the ultraviolet, luminous, infrared and blue-light, normal transmittance of lenses.

14.12.2 Transmittance

The transmittance may be determined by any suitable method, but the reference method shall be the use of a spectrophotometer and calculation using appropriate weighting factors given in tables A1 through A4 of annex A.

14.12.3 Analysis of Results

Criteria for ultraviolet, luminous, infrared and blue-light, normal transmittance are given in sections 7 through 10 for the particular type of device being tested.

14.13 Switching Index Test

14.13.1 Purpose

This test is intended to determine the switching index of an automatic darkening filter lens which requires the measurement of luminous

transmittance over time as the device is exposed to optical radiation from a test light source.

14.13.2 Apparatus

The following test apparatus, or an equivalent apparatus capable of determining compliance with table 3, shall be used. The response time of the test apparatus (between 10% and 90% of recorded peak light intensity) shall be no greater than 10% of the required switching index of the lens under test. The test apparatus shall consist of a light source, detector, trigger light source and a recording device.

The light source shall be a high intensity collimated light source which, when optically coupled to an associated light detector, provides the required intensity to measure the luminous transmittance of the lens under test in its highest shade number state.

The detector shall have a calibrated photopic response, which, when coupled with an associated light source, is capable of measuring the luminous transmittance of the lens under test in its highest shade number state.

The trigger light source shall be a high intensity light source of at least 10,000 lux capable of being either electronically or mechanically switched on.

The recording device shall be a storage oscilloscope or equivalent device capable of recording the output of the detector, in time, and providing output functions of normal transmittance and time.

14.13.3 Procedure

The test specimen (automatic darkening welding filter) shall be maintained at the appropriate test temperature for a minimum of 2 hours before testing and during the period of test. Ambient lighting conditions during testing shall not exceed 16 lux.

The test specimen and light detectors shall be mounted normal to the beam of illumination. Solar or photoelectric power cells shall be shielded from the transmittance light source beam.

Methods shall be employed to ensure that the temperature of the lens under test does not exceed the prescribed test temperature (For example: due to exposure from the transmittance light source).

With the transmittance light source activated, the trigger light source shall be switched to its high illumination state. The luminance variations over time, of the triggering light source at the filter and the transmittance light source through the filter, shall be recorded.

14.13.4 Analysis of Results

The switching index shall be calculated from the integral given in section 12.1 equation 7, taking $t=0$ as the time when recorded illuminance reaches 5000 lux. Failure criteria are given in section 10.12.4 and 10.12.5.

14.14 Light Tightness Test

14.14.1 Purpose

This test is to determine that welding helmets have light sealing capabilities between the lens and the lens holder.

14.14.2 Apparatus

The apparatus shall consist of a device capable of illuminating the entire lens retaining area and confining the light to the exterior surface of the helmet. An example is shown in Figure C3. A shade 14 lens shall be used to test for light leakage. Automatic darkening filter lenses shall be tested with the viewing area covered with an opaque material.

14.14.3 Procedure

The welding helmet shall be held firmly against the seal of the test apparatus and examined for direct light leakage between the lenses, gaskets or other components. The test shall be performed in a darkened room to verify a light tight design when viewed from any angle.

14.14.4 Analysis of Results

Failure criteria are given in section 10.9.2.

15 Warning Label

15.1 Purpose

Warning shall be provided to alert the user when the lens(es) of a protector meets only the basic impact requirements of this standard.

15.2 Label or Tag Requirements

A clearly visible, removable label or hang tag shall be affixed to any protector which does not meet the high impact requirements of this standard. The label or tag shall contain an appropriate warning indicating that the lens meets basic impact requirements, but should not be relied upon for protection from high impact exposures. The label or tag shall also state that it is to be removed only by the user.

Annex A
(normative)
TABLE A1

*Spectral Weighting Factors $W(\lambda)$ for
Effective Far-Ultraviolet Average Transmittance*

Wavelength (nm)	<u>Spectral Weighting Factor $W(\lambda)$</u>
200	0.03
210	0.075
220	0.12
230	0.19
240	0.30
250	0.43
254	0.5
260	0.65
270	1.0
280	0.88
290	0.64
300	0.30
305	0.06
310	0.015
315	0.003

NOTE: This table is a reproduction of Table 10 "Relative Spectral Effectiveness by Wavelength," from *Threshold Limit Values for Chemical Substances and Physical Agents in the Work Environment with Intended Changes for 1982*. Published by the American Conference of Governmental Industrial Hygienists.

TABLE A2
Values of Relative Luminous Efficiency $\bar{y}(\lambda)$ for the CIE 1931 Standard colorimetric Observer
And of Relative Spectral Emittance $S(\lambda)$ For CIE Illuminant A.

$\lambda(\text{nm})$	$\bar{y}(\lambda)$	$S(\lambda)$	$\lambda(\text{nm})$	$\bar{y}(\lambda)$	$S(\lambda)$
380	0.0000	9.80	575	0.9154	110.80
385	0.0001	10.90	580	0.8700	114.44
390	0.0001	12.09	585	0.8163	118.08
395	0.0002	13.35	590	0.7570	121.73
			595	0.6949	125.39
400	0.0004	14.71			
405	0.0006	16.15	600	0.6310	129.04
410	0.0012	17.68	605	0.5668	132.70
415	0.0022	19.29	610	0.5030	136.35
420	0.0040	20.99	615	0.4412	139.99
			620	0.3810	143.62
425	0.0073	22.79			
430	0.0116	24.67	625	0.3210	147.24
435	0.0168	26.64	630	0.2650	150.84
440	0.0230	28.70	635	0.2170	154.42
445	0.0298	30.85	640	0.1750	157.98
			645	0.1382	161.52
450	0.0380	33.09			
455	0.0480	35.41	650	0.1070	165.03
460	0.0600	37.81	655	0.0816	168.51
465	0.0739	40.30	660	0.0610	171.96
470	0.0910	42.87	665	0.0446	175.38
			670	0.0320	178.77
475	0.1126	45.52			
480	0.1390	48.24	675	0.0232	182.12
485	0.1693	51.04	680	0.0170	185.43
490	0.2080	53.91	685	0.0119	188.70
495	0.2586	56.85	690	0.0082	191.93
			695	0.0057	195.12
500	0.3230	59.86			
505	0.4073	62.93	700	0.0041	198.26
510	0.5030	66.06	705	0.0029	201.36
515	0.6082	69.25	710	0.0021	204.41
520	0.7100	72.50	715	0.0015	207.41
			720	0.0010	210.36
525	0.7932	75.79			
530	0.8620	79.13	725	0.0007	213.27
535	0.9149	82.52	730	0.0005	216.12
540	0.9540	85.95	735	0.0004	218.92
545	0.9803	89.41	740	0.0002	221.67
			745	0.0002	224.36
550	0.9950	92.91			
555	1.0000	96.44	750	0.0001	227.00
560	0.9950	100.00	755	0.0001	229.59
565	0.9786	103.58	760	0.0001	232.12
570	0.9520	107.18			

TABLE A3

Relative Spectral Emittance $S(\lambda)$ of CIE Illuminant A for Wavelengths from 700 nm to 2600 nm

λ	$S(\lambda)$	λ	$S(\lambda)$	λ	$S(\lambda)$	λ	$S(\lambda)$	λ	$S(\lambda)$	λ	$S(\lambda)$
700	198.26	1050	298.78	1400	232.72	1750	161.42	2100	108.81	2450	73.94
710	204.41	1060	289.28	1410	230.56	1760	159.63	2110	107.60	2460	73.15
720	210.36	1070	288.66	1420	228.40	1770	157.86	2120	106.40	2470	72.37
730	216.12	1080	287.94	1430	226.23	1780	156.10	2130	105.21	2480	71.60
740	221.67	1090	287.12	1440	224.06	1790	154.37	2140	104.04	2490	70.83
750	227.00	1100	286.20	1450	221.90	1800	152.65	2150	102.88	2500	70.08
760	232.12	1110	285.18	1460	219.74	1810	150.94	2160	101.73	2510	69.33
770	237.01	1120	284.08	1470	217.58	1820	149.25	2170	100.60	2520	68.60
780	241.68	1130	282.90	1480	215.42	1830	147.59	2180	99.48	2530	67.87
790	246.12	1140	281.64	1490	213.27	1840	145.93	2190	98.38	2540	67.15
800	250.83	1150	280.30	1500	211.13	1850	144.30	2200	97.29	2550	66.44
810	254.31	1160	278.89	1510	209.00	1860	142.68	2210	96.21	2560	65.74
820	258.07	1170	277.42	1520	206.87	1870	141.08	2220	95.14	2570	65.05
830	261.60	1180	275.89	1530	204.75	1880	139.50	2230	94.09	2580	64.37
840	264.91	1190	274.29	1540	202.64	1890	137.93	2240	93.05	2590	63.69
850	267.99	1200	272.64	1550	200.54	1900	136.38	2250	92.03	2600	63.02
860	270.86	1210	270.94	1560	198.45	1910	134.85	2260	91.01		
870	273.51	1220	269.20	1570	196.38	1920	133.33	2270	90.01		
880	275.95	1230	267.40	1580	194.31	1930	131.83	2280	89.02		
890	278.18	1240	265.57	1590	192.26	1940	130.35	2290	88.05		
900	280.21	1250	263.70	1600	190.22	1950	128.89	2300	87.08	Calculate by method given in Publication CIE No.15 (E-1.3.1) 1971 "COLORIMETRY," p. 23, par. (b)	
910	282.04	1260	261.79	1610	188.19	1960	127.44	2310	86.13		
920	283.68	1270	259.83	1620	186.18	1970	126.00	2320	85.19		
930	285.12	1280	257.88	1630	184.18	1980	124.59	2330	84.26		
940	286.39	1290	255.88	1640	182.20	1990	123.19	2340	83.34		
950	287.47	1300	253.86	1650	180.23	2000	121.80	2350	82.43	Values start at 700 nm to show overlap with values in Table A2 of this appendix.	
960	288.39	1310	251.81	1660	178.28	2010	120.43	2360	81.53		
970	289.14	1320	249.74	1670	176.34	2020	119.08	2370	80.65		
980	289.72	1330	247.66	1680	174.42	2030	117.74	2380	79.77		
990	290.15	1340	245.56	1690	172.51	2040	116.42	2390	78.91		
1000	290.43	1350	243.45	1700	170.62	2050	115.12	2400	78.06		
1010	290.57	1360	241.32	1710	168.75	2060	113.83	2410	77.21		
1020	290.57	1370	239.18	1720	166.89	2070	112.55	2420	76.38		
1030	290.43	1380	237.04	1730	165.05	2080	111.29	2430	75.56		
1040	290.17	1390	234.88	1740	163.23	2090	110.04	2440	74.75		

TABLE A4
Spectral Weighting Factors
For Blue-Light Hazard

Wavelength (nm)	Blue-Light hazard Factors B(λ)
400	.10
405	.20
410	.40
415	.80
420	.90
425	.95
430	.98
435	1.00
440	1.00
445	.97
450	.94
455	.90
460	.80
465	.70
470	.62
475	.55
480	.45
485	.40
490	.22
495	.16
500-600	$10 \exp [(450-\lambda)/50]$
600-1400	.001

NOTE: This table is a reproduction of part of Table 12, "Spectral Weighting Functions for Assessing Retinal Hazards from Broad Band Optical Sources", from *Threshold Limit Values for Chemical Substances and Physical Agents in the Work Environment with Intended Changes for 1982*, Published by the American Conference of Governmental Industrial Hygiene.

Annex B
(normative)
Test Apparatus

Figure B1 - Lens Test Block

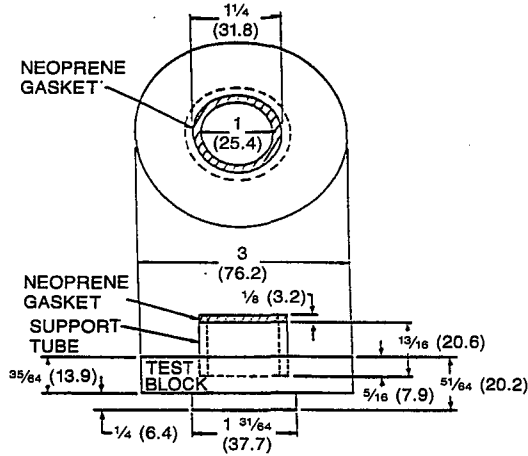

NOTE: (1) One of the test blocks shown are to be inserted in the base plate described in Figure B2 of this standard. The neoprene gasket must have a hardness of 40+/-5 durometer shore A, as determined by American Society for Testing and Materials Standard *Test Method for Rubber Property-Durometer Hardness*, ASTM D2240-2002; a minimum tensile strength of 6895 kPa (1000 psi), as determined by American Society for Testing and Materials *Standard Test Method for Rubber Properties in Tension*, ASTM D412-1998a; and a minimum ultimate elongation of 400%, as determined by ASTM D412-1998a. The support tube made of a suitable rigid material must fit loosely in the recess in the test block, but must have an outside diameter of not less than 31.4 mm (1.234 in). The gasket must be securely bonded to the support tube. The test block must be made of (cold-rolled steel) American Iron and Steel Institute No. C1018, or the equivalent. However, if any diameter of an edged lens is less than 31.8 mm (1.25 in), a substitute support may be used whose outside diameter is equal to, or less than, the smallest diameter of the edged lens. The wall thickness of the neoprene gasket is a nominal 3.2 mm (0.125 in).

Figure B2 - Base Plate for Impact Test Apparatus

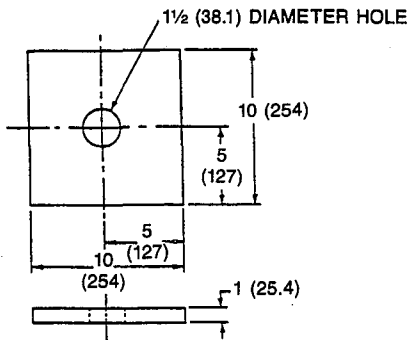

NOTES:

- (1) Only one base plate is required. The material is cold-rolled steel (ground stock), American Iron and Steel Institute No. C1018, or the equivalent. A base of alternate geometric design may be used providing it is an inflexible iron or steel member, and the total intrinsic weight of the member and rigidly attached fixtures of the device itself is not less than 12.25 kg (27 lb).

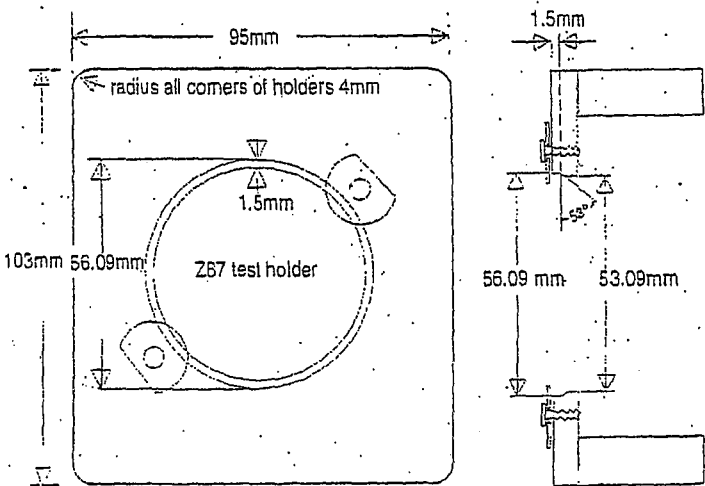
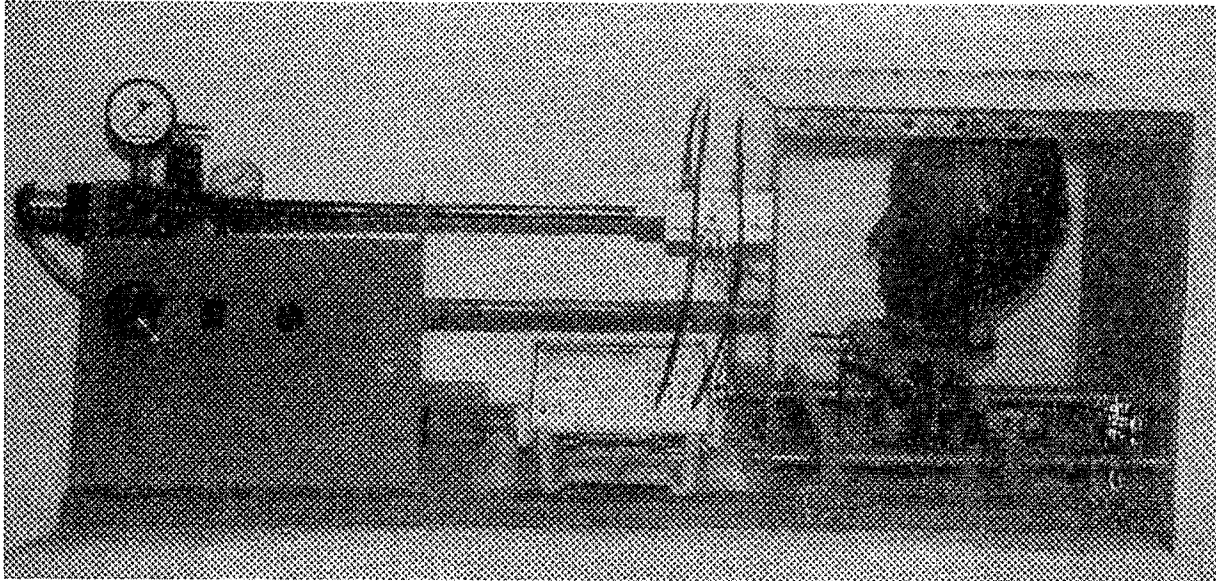

Figure B3 – Lens Fixture for Rx Lens Testing

Annex C
(informative)
Test Apparatus

Figure C1 - High Velocity Impact Test Apparatus



(The unit shown above or its equivalent is suitable for the high velocity impact test.)

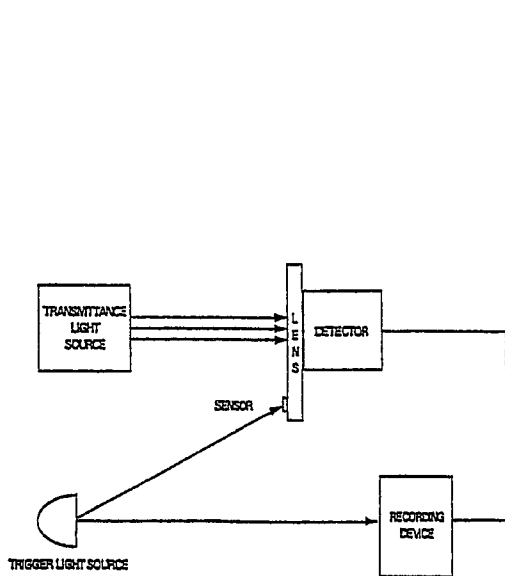

**Figure C2 - Switching Index
Tightness Test Apparatus**

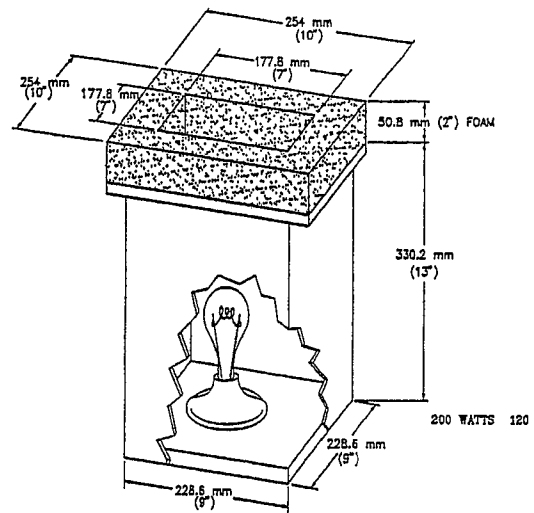

**Figure C3 - Typical Light
Test Set-Up Configuration**

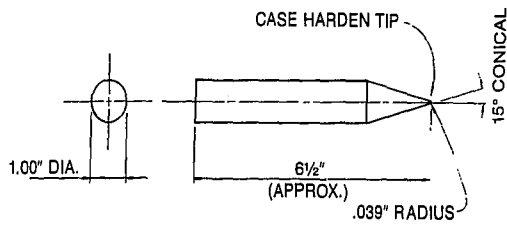

Figure C4
High Mass Impact Missile

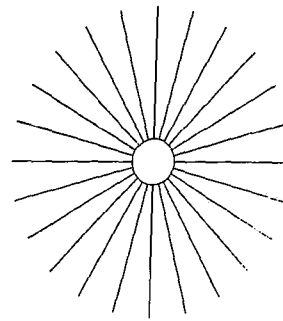
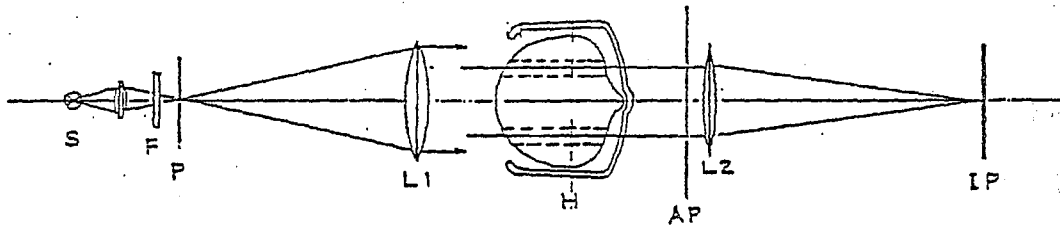

Figure C5
Test Pattern "Sunburst"



- S Small Tungsten Light Source.
- F Interference Filter, Maximum Transmission at 590 +/- 20 nanometers.
- P Pinhole Aperture, Plate with 0.5 mm diameter hole.
- L1 Collimator Lens, $f_l = 1$ meter.
- H Alderson Headform (19 mm diameter through holes through both eyes).
- AP Aperture Plate.
- L2 Telescope Lens, $f_l = 1$ meter
- IP Image Plane with Diffuser and Rectangular Grid Pattern.

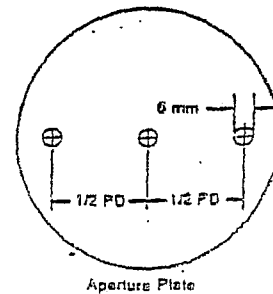

Figure C6
Prism Imbalance Test Apparatus

Annex D Calibration of Test Telescope

The telescope may be calibrated by any of the three methods given below.

(1) The telescope may be calibrated by successively locating the position of best focus with first a standard lens of +0.06 D in front of the objective and then with a standard lens of -0.06 D in front of the objective. The positions of the telescope drawtube or focusing knob, which correspond to the +/-0.06 D positions are marked on a suitable scale. The zero power position is located half the distance between the two marks. It should be verified that with no lens in front of the test telescope, the position of sharpest focus of the target is at the zero power scale position determined above. It is suggested that the scale distance between the +0.06 D position and -0.06 D position be divided into at least twenty equally spaced intervals so as to allow reasonably accurate determination of astigmatism.

(2) If effective focal length, f , of the telescope objective is measured or is known from data furnished by the telescope manufacturer, then calibration of the power scale of the telescope may be done as follows:

Since P , the power of the telescope objective, is the reciprocal of the effective focal length of the objective in meters, if a lens of lower power, such as a plano lens, is placed near the telescope objective, the combined system will have a small change in focal length which causes re-focusing of the telescope to be necessary. Since $P = 1/f$, then $dP = -df/f$ and hence $df = -fdP$. Since the focal length of a typical test telescope is in the order of 200 mm (7.9 in) (and hence it has a power of 5 Ds), the change in focal position produced by putting an acceptable plano lens in front of a telescope is small and hence the change in focal length (change of eyepiece position for best focus) is proportional to the power of the plano lens placed in front of the objective. Having calculated, then, the scale span between the +0.06 D and -0.06 D positions, the zero position must be determined. This is best done by having several operators take a number of readings at the best focus position for the 10.67 m (35 ft) distant target when no lens is in front of the telescope objective, and then averaging those readings. Before taking the readings, each operator should focus the eyepiece first on the cross hairs to suit his individual visual requirements.

(3) Vergence of light from a target at a distance of 10.67 m is $1/10.67 = -0.09372$ D, so the vergence required of the telescope is +0.09372 D to form an image of the target when no test lens is in place. If a lens of +0.06 D is placed in front of the telescope, vergence of light reaching the telescope is -0.09372 D + 0.065 D = -0.03122 D, which corresponds to light from a target at $1/0.03122$ D = 32.03 m (105.1 ft). Similarly, if a lens of -0.06 D is used, vergence of light reaching the telescope is -0.09372 D - 0.065 D = -0.15622 D, which corresponds to light from a target at 6.40 m (21 ft). Therefore, the positions of the telescope focusing knob corresponding to test lens powers of +/-0.06 D can be established by focusing the telescope at targets spaced 32.03 m (105.1 ft) and 6.40 m (21.0 ft) respectively from the telescope.

Annex E
(informative)
Sources for Test Apparatus

Source for All Test Apparatus and Test Patterns:

ICS Laboratories
1072 Industrial Parkway North
Brunswick, OH 44212
(330)220-0515 FAX: (330)220-0516

Source for Alderson Headform:

First Technology Safety Systems
47460 Galleon Drive
Plymouth, MI 48170
(734)451-7878

NOTE: Order "50th percentile male ATD 3215 headform with ears modified to hold spectacles".

Source for High Velocity Impact Test Apparatus:

Skylark Machine
Attn. Gene Dykens
60 Veterans Drive, Unit 2
Holland, MI 49423
(616)396-7906 FAX: (616)396-7940

COLTS Laboratories
Attn. John Young
21915 US 19 N.
Clearwater, FL 33765
(813)725-2323 FAX: (813)725-8890

Source for Prismatic Power Test Apparatus:

Professional Services Industries, Inc.
Pittsburgh Testing Laboratory Division
850 Poplar Street
Pittsburgh, PA 15220
(412)922-4000 FAX(412)922-4014

Source for NBS Special Publication and Sunburst Test Pattern:

ISEA - The Safety Equipment Association
1901 N. Moore Street, Suite 808
Arlington, VA 22209
(703)525-1695 FAX(703)528-2148

Annex F
Referenced Publications

ANSI Z49.1-1999, American National Standard Safety in Welding and Cutting.

ANSI Z89.1-1997, American National Standard for Personnel Protection - Protective Headwear for Industrial Workers - Requirements.

ANSI Z136.1-1993, American National Standard for Safe Use of Lasers.

ANSI/ASQC Z1.4 - 1993, Sampling Procedures and Tables for Inspections by Attributes.

ASTM F803 - Standard Specification for Protective Sports Eyewear

29CFR1910.133 - Eye and Face Protection, OSHA General Industry Standards.

29CFR1915.153 - Eye and Face Protection, OSHA Shipyard Standards.

29CFR1926.102 - Eye and Face Protection, OSHA Construction Industry Standards.

**Annex G
Summary of Marking Requirements**

**Required Marks and Marking Locations by
Product Category**

Required Marks	Removable Lens(es)	Removable Side Protection	Frame*	Non-Replaceable Components Products ¹
Manufacturer's Mark	ALL	ALL	ALL	ALL
"Z87"	FS, G, WH	ALL	ALL	ALL
"Z87-2"			IF APPL ²	
"+" (high impact)	IF APPL			ALL
Shade Number	IF APPL			IF APPL
"S" (special purpose)	IF APPL			IF APPL
"Light/Medium/Dark"	FS-IF APPL			FS-IF APPL
"V" (Variable tint-photochromic)	IF APPL			IF APPL

***Frame Marking Locations on Eye and Face Protectors**

Category	Frame Components Subject to Markings
Spectacles	front, at least one temple and removable sideshields
Goggles	frame and lens housing or carrier
Faceshields	headgear/adaptor and crown
Welding Helmets and Handshields	headgear, shell and lens housing or carrier

¹For non-replaceable component products, including products with non-removable lenses, only one product marking is required.

²Dual lens, non-plano (such as prescription) spectacle frames only.

LEGEND

ALL = all categories of products: spectacles, goggles, face shields and welding helmets

FS = faceshields

G = goggles

WH = welding helmets

IF APPL = if applicable (if the product complies with the appropriate requirements)

Annex H
(Informative)
Eye Injury Report Form























The attached form is provided for users of occupational and educational eye and face protection. completing and returning this form will assist the Z87 Committee on Safety Standards for Eye Protection to improve this standard and develop others, as appropriate. The Eye Injury Report Form is not subject to copyright and may be reproduced as needed.

Eye Injury Report Form	
Please report all work-related and education-related eye injuries to assist the ANSI Z87 Committee on Eye and Face Protection develop improved standards. Eye injuries include injuries to the eyeball, surrounding tissue such as the lids, and the bones forming the eye socket.	
<p>1. Injured worker/student information</p> <p>Worker's/student's initials <small>(first/middle/last)</small> _____</p> <p>Sex <input type="checkbox"/> Male <input type="checkbox"/> Female Age _____</p> <p>Job title/type of work: _____ <small>(describe in detail)</small></p> <p>_____ <small>(e.g., journeyman carpenter-concrete form builder)</small></p> <p>Date of injury (mo/day/yr) ____/____/____</p> <p>Was there 1 day (8hrs) or more of lost work/school-time? <input type="checkbox"/> Yes <input type="checkbox"/> No <input type="checkbox"/> Unknown</p>	<p>2. Employer/Educational institution information</p> <p>Nature of business _____ <small>(describe in detail; e.g., steel ball-bearing manufacturer)</small></p> <p>Contact name _____</p> <p>Title _____</p> <p>Company name _____</p> <p>Address _____</p> <p>City _____ State ____ Zip _____</p> <p>Phone (____) _____ FAX (____) _____</p>
<p>3. Industry type <small>(check one)</small> or describe education institute</p> <p><input type="checkbox"/> Agriculture/forestry/fishing</p> <p><input type="checkbox"/> Mining</p> <p><input type="checkbox"/> Construction</p> <p><input type="checkbox"/> Manufacturing</p> <p><input type="checkbox"/> Transportation</p> <p><input type="checkbox"/> Public Utility/Sanitation</p> <p><input type="checkbox"/> Finance/Insurance/Real estate</p> <p><input type="checkbox"/> Retail/wholesale trade</p> <p><input type="checkbox"/> Services (e.g., lodging/food/health/legal/social/education)</p> <p><input type="checkbox"/> Public Administration (e.g, govt/police/fire/safety/military)</p> <p><input type="checkbox"/> Other <small>(describe)</small>:</p>	<p>4. Part of body injured <small>(Check all that apply)</small></p> <p><input type="checkbox"/> Eyeball, one eye <input type="checkbox"/> Other tissue around eye</p> <p><input type="checkbox"/> Eyeball, both eyes <input type="checkbox"/> Bone, eye socket</p> <p><input type="checkbox"/> Eye lid <input type="checkbox"/> Other: _____</p>
	<p>5. Nature of injury <small>(Check all that apply)</small></p> <p><input type="checkbox"/> Corneal scratch/abrasion <input type="checkbox"/> Thermal burn</p> <p><input type="checkbox"/> Foreign body <u>on</u> eye surface <input type="checkbox"/> Chemical burn</p> <p><input type="checkbox"/> Foreign body <u>in</u> eyeball <input type="checkbox"/> Radiation burn (welder flash)</p> <p><input type="checkbox"/> Puncture of eyeball <input type="checkbox"/> Blunt trauma to eye</p> <p><input type="checkbox"/> Laceration to eye or lid <input type="checkbox"/> Blood in eye</p> <p><input type="checkbox"/> Facial fracture <input type="checkbox"/> Other: _____</p>

<p>6. Source of injury <i>(check one)</i></p> <ul style="list-style-type: none"> <input type="checkbox"/> Chemicals and chemical products (includes wet/dry cement mix) <input type="checkbox"/> Containers <input type="checkbox"/> Furniture and fixtures (includes wall/floor/window coverings) <input type="checkbox"/> Machinery <input type="checkbox"/> Parts and materials (includes building materials/fasteners) <input type="checkbox"/> Persons, plants, animals, and minerals <input type="checkbox"/> Structures and surfaces <input type="checkbox"/> Tools, instruments, and equipment <input type="checkbox"/> Vehicles <input type="checkbox"/> Other sources (scrap/debris) <i>describe:</i> 	<p>7. Injury event or exposure <i>(check one)</i></p> <ul style="list-style-type: none"> <input type="checkbox"/> Contact with objects and equipment <input type="checkbox"/> Falls <input type="checkbox"/> Bodily reaction and exertion <input type="checkbox"/> Exposure to harmful substance or environments <input type="checkbox"/> Transportation accidents <input type="checkbox"/> Fires and explosions <input type="checkbox"/> Assaults and violent acts <input type="checkbox"/> Other events or exposures <i>(describe):</i> 																								
<p>8. At the time of the injury was the worker/student wearing <u>any</u> of the following items: prescription glasses, contact lenses, sunglasses, or safety eye and face protection (e.g., safety glasses, goggles, face shield, welding helmet)? <i>(check one)</i> <input type="checkbox"/> Yes <i>(go to question 9)</i> <input type="checkbox"/> No <i>(skip to question 12)</i> <input type="checkbox"/> Unknown <i>(skip to question 12)</i></p>																									
<p>9. What vision aids and/or eye protection were worn at the time of the injury? <i>(Check all items that were worn)</i></p> <table style="width: 100%; border: none;"> <tr> <td style="width: 33%; vertical-align: top; padding: 2px;"><input type="checkbox"/> Prescription glasses (non-safety)</td> <td style="width: 33%; vertical-align: top; padding: 2px;"><input type="checkbox"/> Goggles--direct vented</td> <td style="width: 33%; vertical-align: top; padding: 2px;"><input type="checkbox"/> Face shield--plastic</td> </tr> <tr> <td style="vertical-align: top; padding: 2px;"><input type="checkbox"/> Contact lenses</td> <td style="vertical-align: top; padding: 2px;"><input type="checkbox"/> Goggles--indirect vented</td> <td style="vertical-align: top; padding: 2px;"><input type="checkbox"/> Face shield--wire mesh</td> </tr> <tr> <td style="vertical-align: top; padding: 2px;"><input type="checkbox"/> Sunglasses (non-safety)</td> <td style="vertical-align: top; padding: 2px;"><input type="checkbox"/> Goggles--non vented</td> <td style="vertical-align: top; padding: 2px;"><input type="checkbox"/> Face shield--plastic mesh</td> </tr> <tr> <td style="vertical-align: top; padding: 2px;"><input type="checkbox"/> Prescription safety glasses with side shields</td> <td style="vertical-align: top; padding: 2px;"><input type="checkbox"/> Goggles--venting unknown</td> <td style="vertical-align: top; padding: 2px;"><input type="checkbox"/> Welding helmet</td> </tr> <tr> <td style="vertical-align: top; padding: 2px;"><input type="checkbox"/> Prescription safety glasses--no side shields</td> <td style="vertical-align: top; padding: 2px;"><input type="checkbox"/> Cup goggles</td> <td style="vertical-align: top; padding: 2px;"><input type="checkbox"/> Welding goggles</td> </tr> <tr> <td style="vertical-align: top; padding: 2px;"><input type="checkbox"/> Non-prescription safety glasses with side protection</td> <td style="vertical-align: top; padding: 2px;"><input type="checkbox"/> Wire mesh goggles</td> <td style="vertical-align: top; padding: 2px;"><input type="checkbox"/> Full-face respirator</td> </tr> <tr> <td style="vertical-align: top; padding: 2px;"><input type="checkbox"/> Non-presc. safety glasses--no side protection</td> <td style="vertical-align: top; padding: 2px;"><input type="checkbox"/> Laser goggles</td> <td></td> </tr> <tr> <td style="vertical-align: top; padding: 2px;"><input type="checkbox"/> Non-presc. safety glasses--side protection unknown</td> <td style="vertical-align: top; padding: 2px;"><input type="checkbox"/> Other <i>(describe):</i></td> <td></td> </tr> </table> <p><i>Complete other side</i></p>		<input type="checkbox"/> Prescription glasses (non-safety)	<input type="checkbox"/> Goggles--direct vented	<input type="checkbox"/> Face shield--plastic	<input type="checkbox"/> Contact lenses	<input type="checkbox"/> Goggles--indirect vented	<input type="checkbox"/> Face shield--wire mesh	<input type="checkbox"/> Sunglasses (non-safety)	<input type="checkbox"/> Goggles--non vented	<input type="checkbox"/> Face shield--plastic mesh	<input type="checkbox"/> Prescription safety glasses with side shields	<input type="checkbox"/> Goggles--venting unknown	<input type="checkbox"/> Welding helmet	<input type="checkbox"/> Prescription safety glasses--no side shields	<input type="checkbox"/> Cup goggles	<input type="checkbox"/> Welding goggles	<input type="checkbox"/> Non-prescription safety glasses with side protection	<input type="checkbox"/> Wire mesh goggles	<input type="checkbox"/> Full-face respirator	<input type="checkbox"/> Non-presc. safety glasses--no side protection	<input type="checkbox"/> Laser goggles		<input type="checkbox"/> Non-presc. safety glasses--side protection unknown	<input type="checkbox"/> Other <i>(describe):</i>	
<input type="checkbox"/> Prescription glasses (non-safety)	<input type="checkbox"/> Goggles--direct vented	<input type="checkbox"/> Face shield--plastic																							
<input type="checkbox"/> Contact lenses	<input type="checkbox"/> Goggles--indirect vented	<input type="checkbox"/> Face shield--wire mesh																							
<input type="checkbox"/> Sunglasses (non-safety)	<input type="checkbox"/> Goggles--non vented	<input type="checkbox"/> Face shield--plastic mesh																							
<input type="checkbox"/> Prescription safety glasses with side shields	<input type="checkbox"/> Goggles--venting unknown	<input type="checkbox"/> Welding helmet																							
<input type="checkbox"/> Prescription safety glasses--no side shields	<input type="checkbox"/> Cup goggles	<input type="checkbox"/> Welding goggles																							
<input type="checkbox"/> Non-prescription safety glasses with side protection	<input type="checkbox"/> Wire mesh goggles	<input type="checkbox"/> Full-face respirator																							
<input type="checkbox"/> Non-presc. safety glasses--no side protection	<input type="checkbox"/> Laser goggles																								
<input type="checkbox"/> Non-presc. safety glasses--side protection unknown	<input type="checkbox"/> Other <i>(describe):</i>																								
<p>10. How was the worker/student injured while wearing the item(s) checked in question 9? <i>(check one)</i></p> <table style="width: 100%; border: none;"> <tr> <td style="width: 50%; vertical-align: top; padding: 2px;"><input type="checkbox"/> Object/chemical went around glasses/protector</td> <td style="width: 50%; vertical-align: top; padding: 2px;"><input type="checkbox"/> Frame broke & caused injury</td> </tr> <tr> <td style="vertical-align: top; padding: 2px;"><input type="checkbox"/> Object went through glasses/protector</td> <td style="vertical-align: top; padding: 2px;"><input type="checkbox"/> Lens shattered & entered eye</td> </tr> <tr> <td style="vertical-align: top; padding: 2px;"><input type="checkbox"/> Object/impact forced glasses/protector into eye</td> <td style="vertical-align: top; padding: 2px;"><input type="checkbox"/> Lens was knocked out of frame</td> </tr> <tr> <td style="vertical-align: top; padding: 2px;"><input type="checkbox"/> Glasses/protector was knocked off</td> <td style="vertical-align: top; padding: 2px;"><input type="checkbox"/> Glasses/protector were lifted up/not in proper position</td> </tr> <tr> <td style="vertical-align: top; padding: 2px;"><input type="checkbox"/> Other <i>(describe):</i></td> <td></td> </tr> </table>		<input type="checkbox"/> Object/chemical went around glasses/protector	<input type="checkbox"/> Frame broke & caused injury	<input type="checkbox"/> Object went through glasses/protector	<input type="checkbox"/> Lens shattered & entered eye	<input type="checkbox"/> Object/impact forced glasses/protector into eye	<input type="checkbox"/> Lens was knocked out of frame	<input type="checkbox"/> Glasses/protector was knocked off	<input type="checkbox"/> Glasses/protector were lifted up/not in proper position	<input type="checkbox"/> Other <i>(describe):</i>															
<input type="checkbox"/> Object/chemical went around glasses/protector	<input type="checkbox"/> Frame broke & caused injury																								
<input type="checkbox"/> Object went through glasses/protector	<input type="checkbox"/> Lens shattered & entered eye																								
<input type="checkbox"/> Object/impact forced glasses/protector into eye	<input type="checkbox"/> Lens was knocked out of frame																								
<input type="checkbox"/> Glasses/protector was knocked off	<input type="checkbox"/> Glasses/protector were lifted up/not in proper position																								
<input type="checkbox"/> Other <i>(describe):</i>																									
<p>11. If the safety eye protection was damaged in the injury event, what type of material was damaged?</p> <p><i>(Check all that apply)</i></p> <ul style="list-style-type: none"> <input type="checkbox"/> Polycarbonate plastic lens/shield <input type="checkbox"/> Acrylic plastic lens/shield <input type="checkbox"/> CR39 or Hi-Index plastic lens <input type="checkbox"/> Other or unknown-type plastic lens/shield <input type="checkbox"/> Glass lens <input type="checkbox"/> Wire or plastic mesh lens/shield <input type="checkbox"/> Plastic frame/headgear <input type="checkbox"/> Metal frame/headgear <input type="checkbox"/> Other <i>(describe):</i> 	<p>12. Describe the medical treatment required other than simple first aid:</p> <p><i>(Check all that apply)</i></p> <ul style="list-style-type: none"> <input type="checkbox"/> Emergency department visit <input type="checkbox"/> Physician/clinic visit <input type="checkbox"/> Eye specialist visit <input type="checkbox"/> Eye surgery--repair or removal of an object <input type="checkbox"/> Eye surgery--removal of the eye <input type="checkbox"/> Hospitalization (≥24hrs) <input type="checkbox"/> Other <i>(describe):</i> <p>Was there a permanent loss of vision? <input type="checkbox"/> Yes <input type="checkbox"/> No</p>																								

Annex I – Selection Chart

The Selection Chart is intended to aid in identifying and selecting the types of eye and face protectors that are available, their capabilities and limitation for the hazard “source” operations listed. This guide is not intended to be the sole reference in selecting the proper eye and face protector.

Selection Chart				Protective Devices
Activity and Assessment	Protector Category and Styles	Limitations	Not Recommended	Protective Devices
● IMPACT				
<p>Chipping, grinding, machining, masonry work, riveting, and sanding.</p> <p>Flying fragments, objects, large chips, particles, sand, dirt, etc.</p>	<p>Spectacles, goggles: B, C, D, E, F, G, H, I, J, K, L. For severe exposure add N. Respirators, R, T.</p> <p>Faceshields shall only be worn over spectacles or goggles.</p> <p>Persons whose vision requires the use of prescription (Rx) lenses shall wear either protective devices fitted with prescription (Rx) lenses or protective devices designed to be worn over regular prescription (Rx) eyewear.</p> <p>Wearers of contact lenses shall also be required to wear appropriate spectacles or goggles depending on the specific hazard. Dusty and/or chemical environments may represent an additional hazard to contact lens wearers. Wearing of contact lenses under an R respirator is permitted.</p> <p>Goggles, helmets and faceshield windows that bear the marking “Z87+” comply with the High Impact Test Requirements. Those with “Z87” markings comply only with Basic Impact Testing Requirements. Spectacle lenses that are marked with the manufacturers logo and a “+” sign comply with the High Impact Test Requirements. Those spectacle lenses marked with the manufacturers logo and no “+” comply only with Basic Impact Testing Requirements. (It is important during the selection process to remember that different product categories are tested at different levels of impact resistance. Goggles are tested at a higher level of impact than spectacles and face shields are tested at a higher level than goggles.)</p> <p>The Z87-2 frame marking indicates the frame meets high impact requirements with a minimum lens thickness of 2mm.</p>	<p>Protective devices do not provide unlimited protection.</p> <p>Note: Caution should be exercised in the use of metal frame protective devices in electrical hazard areas. Metal frame protective devices could potentially cause electrical shock and electrical burns through contact with, or thermal burns from exposure to the hazards of electrical energy, which include radiation from accidental arcs.</p> <p>Atmospheric conditions and the restricted ventilation of the protector can cause lenses to fog. Frequent cleaning may be required.</p>	<p>Protectors that do not provide protection from side exposure.</p> <p>Filter or tinted lenses that restrict light transmittance, unless it is determined that a glare hazard exists. Refer to OPTICAL RADIATION.</p> <p>Use of faceshields alone, without spectacles or goggles.</p>	<div style="display: flex; justify-content: space-around;"> <div style="text-align: center;">  A. Spectacle, No sideshield </div> <div style="text-align: center;">  E. Spectacle, Non-Removable Lens </div> <div style="text-align: center;">  I. Cover Goggle, Direct Ventilation </div> </div> <div style="display: flex; justify-content: space-around; margin-top: 10px;"> <div style="text-align: center;">  B. Spectacle, Half Sideshield </div> <div style="text-align: center;">  F. Spectacle, Lift Front </div> <div style="text-align: center;">  J. Cup Goggle, Direct Ventilation </div> </div>
● HEAT				
<p>Furnace operations, pouring, casting, hot dipping, gas cutting, and welding.</p> <p>Hot sparks</p> <p>Splash from molten metals</p> <p>High temperature exposure</p>	<p>Note: Operations involving heat may also involve optical radiation. (See electric arc, gas, and glare under Optical Radiation below.) Protection from both hazards shall be provided. Faceshields shall only be worn over spectacles or goggles.</p> <p>Goggles, spectacles: B, C, D, E, F, G, H, I, J, K, L. For severe exposure add N. Respirators R, T.</p> <p>Faceshields worn over goggles H, K. Respirators R, T or S, U if optical radiation hazard exists.</p> <p>Screen faceshields, Reflective faceshields over spectacles or goggles.</p>	<p>Spectacles, cup and cover type goggles do not provide unlimited facial protection.</p> <p>Operations involving heat may also involve optical radiation. Protection from both hazards shall be provided.</p>	<p>Protectors that do not provide protection from side exposure.</p> <p>Use of faceshields alone, without spectacles or goggles.</p>	<div style="display: flex; justify-content: space-around;"> <div style="text-align: center;">  C. Spectacle, Full Sideshield </div> <div style="text-align: center;">  G. Cover Goggle, No Ventilation </div> <div style="text-align: center;">  K. Cup Goggle, Indirect Ventilation </div> </div> <div style="display: flex; justify-content: space-around; margin-top: 10px;"> <div style="text-align: center;">  D. Spectacle, Detachable Sideshield </div> <div style="text-align: center;">  H. Cover Goggle, Indirect Ventilation </div> <div style="text-align: center;">  L. Spectacle, Headband Temple </div> </div>
● CHEMICAL				
<p>Acid and chemicals handling, degreasing, plating, splash and irritating mists.</p>	<p>Indirect vented: goggles, eyecup and cover types: G, H, K. For severe exposure, add N. Respirators R, T.</p> <p>Irritating Mist: Special purpose goggles: G. Cover goggle – No ventilation. Respirators R, T.</p>	<p>Provides protection from splash entry with adequate ventilation.</p> <p>Atmospheric conditions and the restricted ventilation of the protector can cause lenses to fog. Frequent cleaning may be required.</p>	<p>Spectacles, welding, helmets, or handshields</p>	<div style="display: flex; justify-content: space-around;"> <div style="text-align: center;">  M. Cover Welding Goggle, Indirect Ventilation </div> <div style="text-align: center;">  Q. Welding Helmet, Lift Front </div> <div style="text-align: center;">  S. Respirator </div> </div>
● DUST				
<p>Woodworking, buffing, general dusty conditions. Nuisance dust.</p>	<p>Goggles, eyecup and cover types: G, H, K, Respirators R, T.</p>	<p>Atmospheric conditions and the restricted ventilation of the protector can cause lenses to fog. Frequent cleaning may be required.</p>	<p>Protectors that do not provide protection from optical radiation.</p> <p>Note: Filter lenses shall meet the requirements for shade designations in Table 1.</p>	<div style="display: flex; justify-content: space-around;"> <div style="text-align: center;">  N. Faceshield </div> <div style="text-align: center;">  T1. Respirator </div> </div>
● OPTICAL RADIATION				
<p>WELDING: Electric Arc</p> <p>Viewing electric arc furnaces and boilers</p>	<p>Note: Welding helmets or handshields shall be used only over spectacles or goggles.</p> <p>TYPICAL FILTER LENS SHADE: 10-14 PROTECTORS: Welding helmets or Welding Shields: O, P, Q. Respirators S, U</p>	<p>Protection from optical radiation is directly related to filter lens density. Select the darkest shade that allows adequate task performance.</p> <p>Note: Filter lenses shall meet the requirements for shade designations in Table 1.</p>	<p>Protectors that do not provide protection from optical radiation.</p> <p>Note: Filter lenses shall meet the requirements for shade designations in Table 1.</p>	<div style="display: flex; justify-content: space-around;"> <div style="text-align: center;">  O. Welding Helmet, hand Hold </div> <div style="text-align: center;">  R. Respirator </div> </div>
<p>WELDING: Gas, and viewing gas-fired furnaces and boilers</p> <p>CUTTING</p>	<p>TYPICAL FILTER LENS SHADE: 4-8. PROTECTORS: Welding goggles, Helmets, Welding Face shields over spectacles or goggles: J, K, L, M, N, P, Q or Respirators, S, U.</p> <p>TYPICAL FILTER LENS SHADE: 3-6. PROTECTORS: Welding goggles, Helmets, Welding face shields: J, K, L, M, N, O, P, Q, or Respirators S, U.</p>	<p>Note: Faceshields and welding helmets shall only be worn over spectacles or goggles.</p>	<p>Use of welding helmets or faceshields alone, without spectacles or goggles.</p>	<div style="display: flex; justify-content: space-around;"> <div style="text-align: center;">  T2. Respirator </div> </div>
<p>TORCH BRAZING</p> <p>TORCH SOLDERING.</p> <p>GLARE</p>	<p>TYPICAL FILTER LENS SHADE: 3-4. PROTECTORS: Welding goggles, Helmets, Welding face shields: J, K, L, M, N, O, P, Q, or Respirators, S, U.</p> <p>TYPICAL FILTER LENS SHADE: 1.5-3. PROTECTORS: Spectacles or Welding Faceshield over spectacles: B, C, D, E, F, N. or Respirators, S, U.</p> <p>Spectacle: A, B, Faceshields N over spectacles or goggles.</p>	<p>Shaded or Special Purpose lenses, as suitable. Note: Refer to Section 6.2.4.1 Special Purpose Lenses.</p>	<p>Use of faceshields alone, without spectacles or goggles.</p>	<div style="display: flex; justify-content: space-around;"> <div style="text-align: center;">  P. Welding Helmet, Stationary Window </div> <div style="text-align: center;">  U. Respirator </div> </div>



